



MZ2Q-CFLPSKU0

MZ2Q-C

SENSORS FOR C-SLOT CYLINDERS

SICK
Sensor Intelligence.



Ordering information

Type	Part no.
MZ2Q-CFLPSKU0	1115196

Other models and accessories → www.sick.com/MZ2Q-C



Detailed technical data

Features

Cylinder type	C-slot
Preferred manufacturer slot	Festo
Detection zone	0 mm ... 50 mm
Housing length	19.5 mm
Switching output	2 x PNP
Output function	NO
Electrical wiring	DC 4-wire
Enclosure rating	IP67 ¹⁾
IO-Link functions	Standard functions
Adjustment	
Teach-in control panel	Teaching in switching points 1 and 2
IO-Link	Disabling teach-in pushbutton Teaching in switching points 1 and 2 Tolerance band for switching points in 5 stages

¹⁾ According to EN 60529.

Mechanics/electronics

Detection zone	0 mm ... 50 mm
Supply voltage	12 V DC ... 30 V DC
Power consumption	Typ. 25 mA, without load
Voltage drop	≤ 2.2 V
Continuous current I_a	≤ 100 mA

¹⁾ U_b and T_a constant.

Protection class	III
Hysteresis, typ.	1 mT
Reproducibility	≤ 0.1 mT ¹⁾
Reverse polarity protection	Yes
Short-circuit protection	Yes
Teach-in	Yes
Power-up pulse protection	Yes
Ambient operating temperature	-20 °C ... +75 °C
Shock and vibration resistance	30 g, 11 ms / 10 ... 55 Hz, 1 mm
EMC	According to EN 60947-5-2
Connection type	Cable, 4-wire, 2 m
Connection type Detail	
Cable diameter	Ø 2.6 mm
Bending radius	With fixed installation > 5 x cable diameter For flexible use > 10 x cable diameter
Cable outlet	Axial
Material	
Housing	Plastic
Cable	PUR
UL File No.	NRKH.E181493 & NRKH7.E181493

¹⁾ Ub and Ta constant.

Safety-related parameters

MTTF_D	799 years
DC_{avg}	0%
T_M (mission time)	20 years

Communication interface

Communication interface	IO-Link V1.0
Communication Interface detail	COM2 (38,4 kBaud)
Cycle time	2.3 ms
Process data length	2 Bit
Process data structure	Bit 0 = switching signal Q _{L1} Bit 1 = switching signal Q _{L2} Bit 2 ... 7 = empty

Classifications

eCl@ss 5.0	27270104
eCl@ss 5.1.4	27270104
eCl@ss 6.0	27270104
eCl@ss 6.2	27270104
eCl@ss 7.0	27270104
eCl@ss 8.0	27270104
eCl@ss 8.1	27270104

eCl@ss 9.0	27270104
eCl@ss 10.0	27270104
eCl@ss 11.0	27270104
eCl@ss 12.0	27274301
ETIM 5.0	EC002544
ETIM 6.0	EC002544
ETIM 7.0	EC002544
ETIM 8.0	EC002544
UNSPSC 16.0901	39122230

Installation note

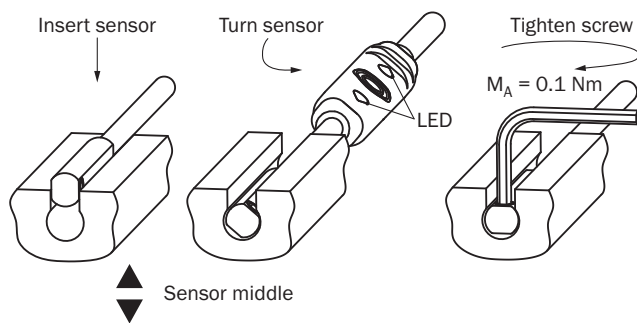

Connection diagram

Cd-548

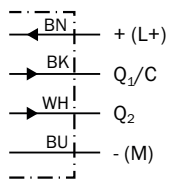

Dimensional drawing (Dimensions in mm (inch))

Cable

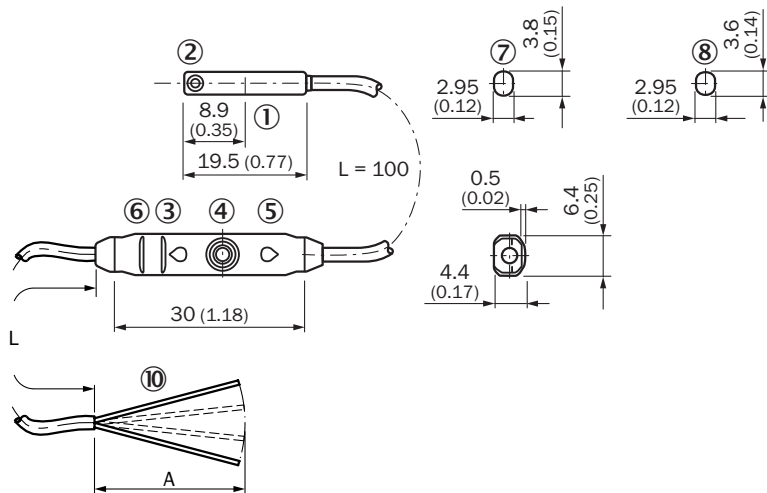





- ① Center of sensor element
- ② Fixing screw SW 1.3
- ③ Display LED
- ④ Teach-in button
- ⑤ Display LED
- ⑥ Ribbing for cable ties
- ⑦ For SMC/ Bimba cylinder (MZ2Q-CSxxxx)
- ⑧ For festo cylinder (MZ2Q-CFxxxx)
- ⑨ Connection

Part no.	Type	L	A	Number of cores
1042237	MZ2Q-CSSPSKU0	2 m	61-65	4
1042241	MZ2Q-CFSPSKU0	2 m	61-65	4
1115196	MZ2Q-CFLPSKU0	2 m	61-65	4
1046234	MZ2Q-CSSNSKUA	3 m	61-65	4
1051588	MZ2Q-CSSPSKUAS05	3 m	61-65	4

Recommended accessories

Other models and accessories → www.sick.com/MZ2Q-C

	Brief description	Type	Part no.
Brackets for cylinder sensors			
	1 piece, Mounting bracket on round body cylinder with piston diameter of 12 mm, ambient temperature min 0 °C max 50 °C, plastic, Aluminum	BEF-KHZ-RC-12	2077673
	1 piece, Mounting bracket on round body cylinder with piston diameter of 16 mm, ambient temperature min 0 °C max 50 °C, plastic, Aluminum	BEF-KHZ-RC-16	2077672
	1 piece, Mounting bracket on round body cylinder with piston diameter of 20 mm, ambient temperature min 0 °C max 50 °C, plastic, Aluminum	BEF-KHZ-RC-20	2077671
	1 piece, Mounting bracket on round body cylinder with piston diameter of 25 mm, ambient temperature min 0 °C max 50 °C, plastic, Aluminum	BEF-KHZ-RC-25	2077670
	1 piece, Mounting bracket on round body cylinder with piston diameter of 32 mm, ambient temperature min 0 °C max 50 °C, plastic, Aluminum	BEF-KHZ-RC-32	2077669

	Brief description	Type	Part no.
	1 piece, Mounting bracket on round body cylinder with piston diameter of 40 mm, ambient temperature min 0 °C max 50 °C, plastic, Aluminum	BEF-KHZ-RC-40	2077668
	1 piece, Mounting bracket on round body cylinder with piston diameter of 50 mm, ambient temperature min 0 °C max 50 °C, plastic, Aluminum	BEF-KHZ-RC-50	2077667
	1 piece, Mounting bracket on round body cylinder with piston diameter of 63 mm, ambient temperature min 0 °C max 50 °C, plastic, Aluminum	BEF-KHZ-RC-63	2077666
	1 piece, Mounting bracket on round body cylinder with piston diameter of 1 mm ... 130 mm, ambient temperature min -30 °C max 80 °C, stainless steel, Aluminum	BEF-KHZ-RC1-130	2077686
	1 piece, Mounting bracket on round body cylinder with piston diameter of 1 mm ... 25 mm, ambient temperature min -30 °C max 80 °C, stainless steel, Aluminum	BEF-KHZ-RC1-25	2077685
Others			
	EtherCAT IO-Link Master, IO-Link V1.1, Port Class A, power supply via 7/8" cable 24 V / 8 A, fieldbus connection via M12 cable		On request
	PROFINET IO-Link Master, IO-Link V1.1, Port Class A, power supply via 7/8" cable 24 V / 8 A, fieldbus connection via M12 cable		On request

SICK AT A GLANCE

SICK is one of the leading manufacturers of intelligent sensors and sensor solutions for industrial applications. A unique range of products and services creates the perfect basis for controlling processes securely and efficiently, protecting individuals from accidents and preventing damage to the environment.

We have extensive experience in a wide range of industries and understand their processes and requirements. With intelligent sensors, we can deliver exactly what our customers need. In application centers in Europe, Asia and North America, system solutions are tested and optimized in accordance with customer specifications. All this makes us a reliable supplier and development partner.

Comprehensive services complete our offering: SICK LifeTime Services provide support throughout the machine life cycle and ensure safety and productivity.

For us, that is “Sensor Intelligence.”

WORLDWIDE PRESENCE:

Contacts and other locations –www.sick.com