



WTB8L-P2211

W8 Laser

MINIATURE PHOTOELECTRIC SENSORS

SICK
Sensor Intelligence.



Ordering information

Type	Part no.
WTB8L-P2211	6033227

Included in delivery: BEF-W100-A (1)

Other models and accessories → www.sick.com/W8_Laser

Illustration may differ



Detailed technical data

Features

Sensor/ detection principle	Photoelectric proximity sensor, Background suppression
Dimensions (W x H x D)	11 mm x 31 mm x 20 mm
Housing design (light emission)	Rectangular
Sensing range max.	5 mm ... 100 mm ¹⁾
Sensing range	20 mm ... 100 mm ¹⁾
Type of light	Visible red light
Light source	Laser ²⁾
Light spot size (distance)	Ø 1 mm (100 mm)
Wave length	650 nm
Laser class	1
Adjustment	Potentiometer, 4 turns
Special applications	Detecting small objects, Detection of objects moving at high speeds
Test input sender off	TE to +Vs

¹⁾ Object with 90 % reflectance (referred to standard white, DIN 5033).

²⁾ Average service life: 100,000 h at T_U = +25 °C.

Mechanics/electronics

Supply voltage	10 V DC ... 30 V DC ¹⁾
-----------------------	-----------------------------------

¹⁾ Limit values when operated in short-circuit protected network: max. 8 A.

²⁾ May not exceed or fall below U_v tolerances.

³⁾ Without load.

⁴⁾ Signal transit time with resistive load.

⁵⁾ With light/dark ratio 1:1.

⁶⁾ A = V_S connections reverse-polarity protected.

⁷⁾ B = inputs and output reverse-polarity protected.

⁸⁾ D = outputs overcurrent and short-circuit protected.

Ripple	± 10 % ²⁾
Current consumption	30 mA ³⁾
Switching output	PNP
Switching mode	Light/dark switching
Switching mode selector	Selectable via light/dark rotary switch
Signal voltage PNP HIGH/LOW	Approx. $V_S - 1.8 \text{ V} / 0 \text{ V}$
Output current I_{max}	≤ 100 mA
Response time	≤ 0.25 ms ⁴⁾
Switching frequency	2,000 Hz ⁵⁾
Connection type	Male connector M8, 4-pin
Circuit protection	A ⁶⁾ B ⁷⁾ D ⁸⁾
Weight	10 g
Housing material	Plastic, ABS
Optics material	Plastic, PMMA
Enclosure rating	IP67
Items supplied	Stainless steel mounting bracket (1.4301/304) BEF-W100-A
Ambient operating temperature	-10 °C ... +50 °C
Ambient storage temperature	-40 °C ... +70 °C

¹⁾ Limit values when operated in short-circuit protected network: max. 8 A.

²⁾ May not exceed or fall below U_V tolerances.

³⁾ Without load.

⁴⁾ Signal transit time with resistive load.

⁵⁾ With light/dark ratio 1:1.

⁶⁾ A = V_S connections reverse-polarity protected.

⁷⁾ B = inputs and output reverse-polarity protected.

⁸⁾ D = outputs overcurrent and short-circuit protected.

Safety-related parameters

MTTF_D	453 years
DC_{avg}	0%

Classifications

ECl@ss 5.0	27270904
ECl@ss 5.1.4	27270904
ECl@ss 6.0	27270904
ECl@ss 6.2	27270904
ECl@ss 7.0	27270904
ECl@ss 8.0	27270904
ECl@ss 8.1	27270904
ECl@ss 9.0	27270904
ECl@ss 10.0	27270904
ECl@ss 11.0	27270904

ETIM 5.0	EC002719
ETIM 6.0	EC002719
ETIM 7.0	EC002719
UNSPSC 16.0901	39121528

Connection diagram

Cd-078

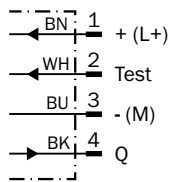

Characteristic curve

WTB8L, 100 mm

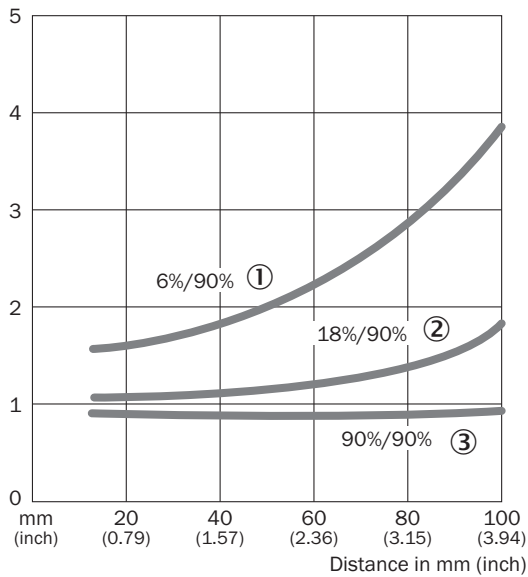

- ① Sensing range on black, 6% remission
- ② Sensing range on gray, 18 % remission
- ③ Sensing range on white, 90% remission

Sensing range diagram

WTB8, 100 mm

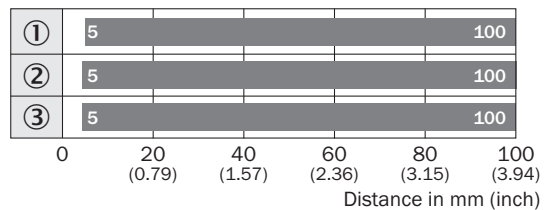

■ Sensing range

- ① Sensing range on black, 6% remission
- ② Sensing range on gray, 18 % remission
- ③ Sensing range on white, 90% remission

Adjustments

WTB8

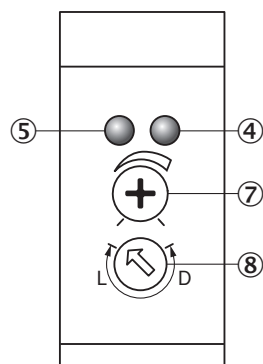

- ④ Orange LED indicator : switching output active
- ⑤ LED indicator green: stability indicator
- ⑦ Adjustment of sensing range
- ⑧ Light/ dark rotary switch: L = light switching, D = dark switching

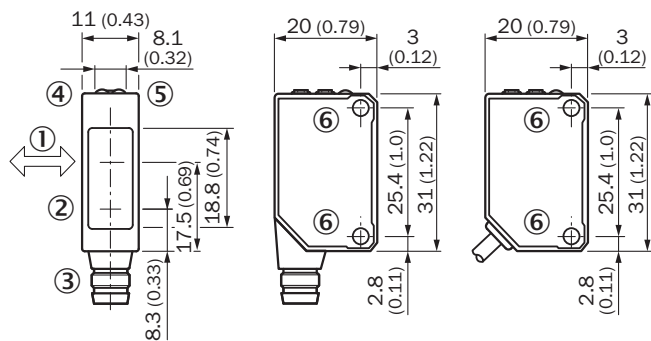

Dimensional drawing (Dimensions in mm (inch))



- ① Standard direction
- ② Center of optical axis, sender
- ③ Connection
- ④ Orange LED indicator : switching output active
- ⑤ LED indicator green: stability indicator
- ⑥ Threaded mounting hole M3

Recommended accessories

Other models and accessories → www.sick.com/W8_Laser

	Brief description	Type	Part no.
Plug connectors and cables			
	Head A: female connector, M8, 4-pin, straight, A-coded Head B: Flying leads Cable: Sensor/actuator cable, PVC, unshielded, 5 m	YF8U14-050VA3XLEAX	2095889
	Head A: male connector, M8, 4-pin, straight Head B: - Cable: unshielded	STE-0804-G	6037323

SICK AT A GLANCE

SICK is one of the leading manufacturers of intelligent sensors and sensor solutions for industrial applications. A unique range of products and services creates the perfect basis for controlling processes securely and efficiently, protecting individuals from accidents and preventing damage to the environment.

We have extensive experience in a wide range of industries and understand their processes and requirements. With intelligent sensors, we can deliver exactly what our customers need. In application centers in Europe, Asia and North America, system solutions are tested and optimized in accordance with customer specifications. All this makes us a reliable supplier and development partner.

Comprehensive services complete our offering: SICK LifeTime Services provide support throughout the machine life cycle and ensure safety and productivity.

For us, that is “Sensor Intelligence.”

WORLDWIDE PRESENCE:

Contacts and other locations –www.sick.com