



# L40E-21KA1A

L4000 Systems

**SAFETY SINGLE-BEAM SENSORS**

**SICK**  
Sensor Intelligence.



### Ordering information

Scanning range	Model	Housing material	System part	Type	Part no.
16 m	M18 axial	Plastic	Receiver	L40E-21KA1A	6027338

Other models and accessories → [www.sick.com/L4000\\_Systems](http://www.sick.com/L4000_Systems)



### Detailed technical data

#### Features

<b>Scanning range</b>	16 m
<b>Number of beams</b>	1
<b>Detection capability</b>	30 mm
<b>Optical axis</b>	Axial
<b>Response time</b>	0.4 ms
<b>Response time</b>	0.4 ms + Test device response time (UE401)

#### Safety-related parameters

<b>Type</b>	Type 4 (IEC 61496-1) <sup>1)</sup>
<b>Safety integrity level</b>	SIL3 (IEC 61508) <sup>1)</sup>
<b>Category</b>	Category 4 (EN ISO 13849) <sup>1)</sup>
<b>Performance level</b>	PL e (EN ISO 13849) <sup>1)</sup>
<b>PFH<sub>D</sub> (mean probability of a dangerous failure per hour)</b>	$2.9 \times 10^{-10}$ (EN ISO 13849) <sup>1)</sup>
<b>T<sub>M</sub> (mission time)</b>	20 years (EN ISO 13849) <sup>1)</sup>

<sup>1)</sup> Only in conjunction with UE401.

#### Interfaces

<b>Connection type</b>	Male connector M12, 4-pin, straight
<b>Display elements</b>	LED

#### Electrical data

<b>Protection class</b>	III (IEC 61140)
<b>Supply voltage V<sub>S</sub></b>	24 V DC (19.2 V DC ... 28.8 V DC)
<b>Power consumption</b>	≤ 30 mA

#### Mechanical data

<b>Design</b>	Cylindrical
<b>Dimensions (diameter x length)</b>	M18 x 97.7 mm

<b>Housing material</b>	Plastic
<b>Lens material</b>	Glass
<b>Weight</b>	30 g

## Ambient data

<b>Enclosure rating</b>	IP67 (EN 60529)
<b>Ambient operating temperature</b>	-20 °C ... +55 °C
<b>Storage temperature</b>	-25 °C ... +75 °C
<b>Air humidity</b>	15 % ... 95 %, Non-condensing
<b>Vibration resistance</b>	5 g, 10 Hz ... 55 Hz (IEC 60068-2-6)
<b>Shock resistance</b>	10 g, 16 ms (IEC 60068-2-29)

## Other information

<b>Aperture angle/receiving angle</b>	± 2.5° / ± 2.5°
---------------------------------------	-----------------

## Classifications

<b>eCl@ss 5.0</b>	27272701
<b>eCl@ss 5.1.4</b>	27272701
<b>eCl@ss 6.0</b>	27272701
<b>eCl@ss 6.2</b>	27272701
<b>eCl@ss 7.0</b>	27272701
<b>eCl@ss 8.0</b>	27272701
<b>eCl@ss 8.1</b>	27272701
<b>eCl@ss 9.0</b>	27272701
<b>eCl@ss 10.0</b>	27272701
<b>eCl@ss 11.0</b>	27272701
<b>eCl@ss 12.0</b>	27272701
<b>ETIM 5.0</b>	EC001831
<b>ETIM 6.0</b>	EC001831
<b>ETIM 7.0</b>	EC001831
<b>ETIM 8.0</b>	EC001831
<b>UNSPSC 16.0901</b>	46171620





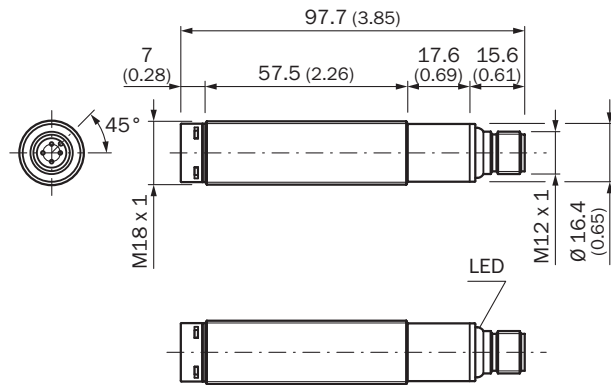



### Dimensional drawing (Dimensions in mm (inch))



M18, axial, straight



### Recommended accessories

Other models and accessories → [www.sick.com/L4000\\_Systems](http://www.sick.com/L4000_Systems)

	Brief description	Type	Part no.
<b>Alignment aids</b>			
	Adapter AR60 for M18 sensors (L41 and L21)	AR60 adapter, M18 sensors	5313533
<b>Deflector mirrors</b>			
	Horizontal deflection, 75 mm x 80 mm reflector surface, Glass, Incl. mounting kit (2 x swivel mount)	PNS75-008	1026647
	Horizontal deflection, 96 mm x 124 mm reflector surface, Glass	PSK1	1005229
	Deflector mirror for 90° deflection, mirror surface 97 mm x 80 mm, not suitable for column mounting, Glass, mounting hardware included	PSK45	5306053
<b>Mounting brackets and plates</b>			
	Mounting bracket for M18 sensors, steel, zinc coated, without mounting hardware	BEF-WN-M18	5308446
<b>Plug connectors and cables</b>			
	Head A: female connector, M12, 4-pin, straight, A-coded Head B: Flying leads Cable: Sensor/actuator cable, PVC, unshielded, 5 m	YF2A14-050VB3XLEAX	2096235
	Head A: female connector, M12, 4-pin, angled, A-coded Head B: Flying leads Cable: Sensor/actuator cable, PVC, unshielded, 5 m	YG2A14-050VB3XLEAX	2095897
	Head A: female connector, M12, 4-pin, straight Cable: unshielded	DOS-1204-G	6007302

	Brief description	Type	Part no.
	Head A: female connector, M12, 4-pin, angled Cable: unshielded	DOS-1204-W	6007303
Switching amplifiers			
	<ul style="list-style-type: none"> <li>• <b>Applications:</b> Evaluation unit</li> <li>• <b>Compatible sensor types:</b> L4000 Systems single-beam photoelectric safety switches</li> </ul>	UE401-A0010	6027343

## SICK AT A GLANCE

SICK is one of the leading manufacturers of intelligent sensors and sensor solutions for industrial applications. A unique range of products and services creates the perfect basis for controlling processes securely and efficiently, protecting individuals from accidents and preventing damage to the environment.

We have extensive experience in a wide range of industries and understand their processes and requirements. With intelligent sensors, we can deliver exactly what our customers need. In application centers in Europe, Asia and North America, system solutions are tested and optimized in accordance with customer specifications. All this makes us a reliable supplier and development partner.

Comprehensive services complete our offering: SICK LifeTime Services provide support throughout the machine life cycle and ensure safety and productivity.

For us, that is “Sensor Intelligence.”

## WORLDWIDE PRESENCE:

Contacts and other locations –[www.sick.com](http://www.sick.com)