



YF2A15-020UB5M2A15

SICK
Sensor Intelligence.



Ordering information

Type	Part no.
YF2A15-020UB5M2A15	2096009

Other models and accessories → www.sick.com/



Detailed technical data

Technical specifications

Accessory group	Plug connectors and cables						
Accessory family	Connection cables						
Connection type head A	Female connector, M12, 5-pin, straight, A-coded						
Connection type head B	Male connector, M12, 5-pin, straight, A-coded						
Locking plug connector	Screw connection						
Connector material	TPU						
Connector color	Black						
Locking nut material	Zinc die-cast, nickel-plated						
Seal material	FKM						
Tightening torque	0.6 Nm						
Width across flats	13						
Cable	2 m, 5-wire, PUR, halogen-free						
Jacket material	PUR, halogen-free						
Jacket color	Black						
Cable diameter	4.8 mm						
Conductor cross-section	0.34 mm ²						
Shielding	Unshielded						
Bending radius	<table border="0"> <tr> <td>Flexible use</td> <td>> 10 x cable diameter</td> </tr> <tr> <td>Stationary position</td> <td>> 5 x cable diameter</td> </tr> <tr> <td>Drag chain operation</td> <td>> 10 x cable diameter</td> </tr> </table>	Flexible use	> 10 x cable diameter	Stationary position	> 5 x cable diameter	Drag chain operation	> 10 x cable diameter
Flexible use	> 10 x cable diameter						
Stationary position	> 5 x cable diameter						
Drag chain operation	> 10 x cable diameter						
Bending cycles	10,000,000						
Reference voltage	≤ 125 V DC						
Rated impulse voltage	1.5 kV						
Current loading	4 A						
Traversing speed	3 m/s						
Travelling distance	10 m						
Acceleration	≤ 10 m/s ²						
Signal type	Sensor/actuator cable						
Torsion force	180° / 1 m						

Torsion cycles	2,000,000								
Cycles per minutes	35								
Application	Zones with oils and lubricants Drag chain operation								
Authorizations	CE UL								
UL File No.	E335179								
Enclosure rating	IP65 / IP66K / IP67								
Ambient operating temperature	<table border="0"> <tr> <td>Flexible use</td> <td>-25 °C ... +80 °C</td> </tr> <tr> <td>Stationary position</td> <td>-40 °C ... +80 °C</td> </tr> <tr> <td>Drag chain operation</td> <td>-25 °C ... +80 °C</td> </tr> <tr> <td>Head</td> <td>-25 °C ... +85 °C</td> </tr> </table>	Flexible use	-25 °C ... +80 °C	Stationary position	-40 °C ... +80 °C	Drag chain operation	-25 °C ... +80 °C	Head	-25 °C ... +85 °C
Flexible use	-25 °C ... +80 °C								
Stationary position	-40 °C ... +80 °C								
Drag chain operation	-25 °C ... +80 °C								
Head	-25 °C ... +85 °C								
Contamination rating	3								
Insulation resistance	100 MΩ								
Overvoltage category	III								
Specific insulation resistance	30 mΩ								

Classifications

ECl@ss 6.0	27279218
ECl@ss 7.0	27279218
ECl@ss 8.0	27279218
ECl@ss 9.0	27060311
ECl@ss 10.0	27060311
ECl@ss 11.0	27060311
ETIM 7.0	EC001855

Dimensional drawing (Dimensions in mm (inch))

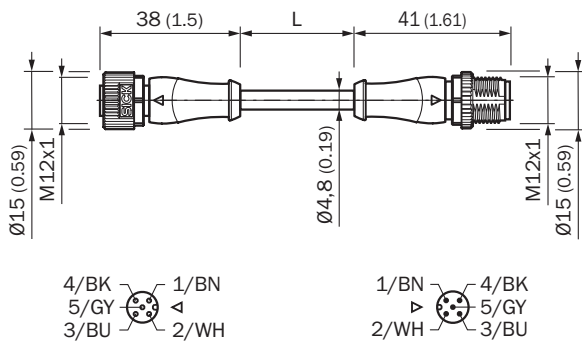

Recommended accessories

Other models and accessories → www.sick.com/

	Brief description	Type	Part no.
Other mounting accessories			
	1 piece, M12 mounting key set for SW13 with calibrated torque 0.6 Nm	TOOL-TW06M12AF13	5337208

SICK AT A GLANCE

SICK is one of the leading manufacturers of intelligent sensors and sensor solutions for industrial applications. A unique range of products and services creates the perfect basis for controlling processes securely and efficiently, protecting individuals from accidents and preventing damage to the environment.

We have extensive experience in a wide range of industries and understand their processes and requirements. With intelligent sensors, we can deliver exactly what our customers need. In application centers in Europe, Asia and North America, system solutions are tested and optimized in accordance with customer specifications. All this makes us a reliable supplier and development partner.

Comprehensive services complete our offering: SICK LifeTime Services provide support throughout the machine life cycle and ensure safety and productivity.

For us, that is “Sensor Intelligence.”

WORLDWIDE PRESENCE:

Contacts and other locations –www.sick.com