



MOC3ZA-KAZ33A3

Standstill Monitor

SAFE MOTION MONITORING AND CONTROL

SICK
Sensor Intelligence.



Illustration may differ



Ordering information

Type	Part no.
MOC3ZA-KAZ33A3	6044982

Other models and accessories → www.sick.com/Standstill_Monitor

Detailed technical data

Safety-related parameters

Safety integrity level	SIL3 (IEC 61508)
Category	Category 4 (EN ISO 13849)
Performance level	PL e (EN ISO 13849)
PFH_D (mean probability of a dangerous failure per hour)	41 x 10 ⁻⁹ (EN ISO 13849)
T_M (mission time)	20 years (EN ISO 13849)
Stop category	1 (EN 60204-1)

Functions

Drive safety functions	Standstill
-------------------------------	------------

Interfaces

Connection type	Screw-type terminals, plug-in screw-type terminals
Conductor cross section	Single wire or fine wire (1x): 0.5 mm ² ... 2.5 mm ² Fine wire with ferrule according to EN 46288 (1x): 0.5 mm ² ... 2.5 mm ²
Encoder interface	Motor voltage measuring

Electrical data

Operating data

Supply voltage (A1/A2)	230 V (184 V ... 253 V)
Voltage type	AC
Residual ripple	10 %
Maximum power consumption	≤ 6 VA
Supply voltage of semiconductor application diagnostic outputs (A3/A4)	24 V DC (11 V DC ... 30 V DC)
Residual ripple	10 %

Measurement inputs (L1/L2/L3)

Measured/motor voltage	≤ 690 V AC
For UL 508 applications only	≤ 600 V AC

Voltage threshold U_{an}	20 mV ... 400 mV, adjustable
Standstill time t_s	0.2 s ... 6 s, adjustable
Hysteresis (for detection of running motor)	100 %
Response time	≤ 100 ms

Safety outputs: Normally open contact (13/14, 23/24, 33/34); positively guided N/C contacts: Normally closed contact (41/42)

Contact configuration (safety contacts)	3 contacts NO, 1 contact NC
Contact type	Relay, positively guided
Nominal switching voltage	250 V AC
Switching capacity in accordance with AC 15	N/O: 3 A/230 V AC (EN 60947-5-1) N/C: 1 A/230 V AC (EN 60947-5-1)
Switching capacity in accordance with DC 13	1 A/24 V DC (EN 60947-5-1)
Maximum switching frequency	≤ 1,200 /h
Contact service life at 230 V / 5 A (AC) $\cos \varphi = 1$	≥ 2 x 10 ⁵ switching operations
Mechanical life	≥ 50 x 10 ⁶ switching operations

Application diagnostic outputs

Semiconductor outputs (ON, ERR)	Electrically isolated supply via A3/A4 $I_{max} = 100$ mA (short-circuit protected) ON for Release, ERR for Error
Signal contacts 53/54 (normally open contact)	3 A/250 V AC G. P.

Mechanical data

Dimensions (W x H x D)	45 mm x 112 mm x 121 mm
Weight	400 g
Mounting	35 mm mounting rail according to EN 60715

Ambient data

Enclosure rating	Terminals	IP20 (EN 60529)
	Housing	IP40 (EN 60529)
Climate conditions according to		25/060/04 (EN 60068-1)
Vibration resistance		10 Hz ... 55 Hz (EN 60068-2-6)
Shock resistance	Single shock	30 g, 11 ms (EN 60068-2-27)

Classifications

eCl@ss 5.0	27371990
eCl@ss 5.1.4	27371990
eCl@ss 6.0	27371819
eCl@ss 6.2	27371819
eCl@ss 7.0	27371819
eCl@ss 8.0	27371819
eCl@ss 8.1	27371819
eCl@ss 9.0	27371819

MOC3ZA-KAZ33A3 | Standstill Monitor

SAFE MOTION MONITORING AND CONTROL

eCl@ss 10.0	27371819
eCl@ss 11.0	27371819
eCl@ss 12.0	27371819
ETIM 5.0	EC001449
ETIM 6.0	EC001449
ETIM 7.0	EC001449
ETIM 8.0	EC001449
UNSPSC 16.0901	41113704

Dimensional drawing (Dimensions in mm (inch))

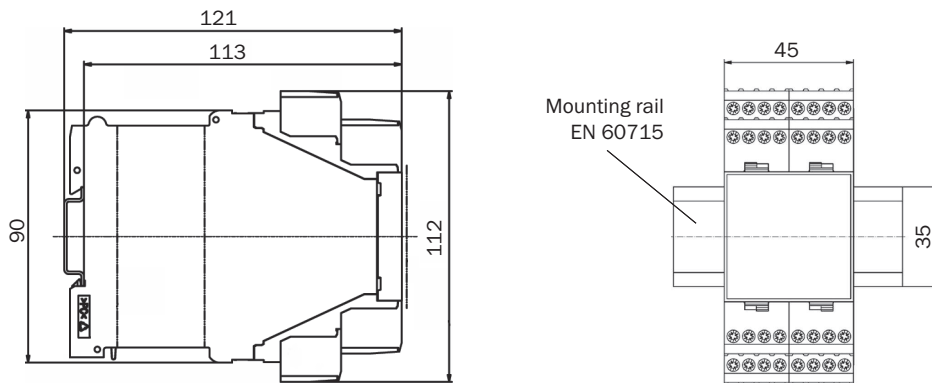

Connection diagram

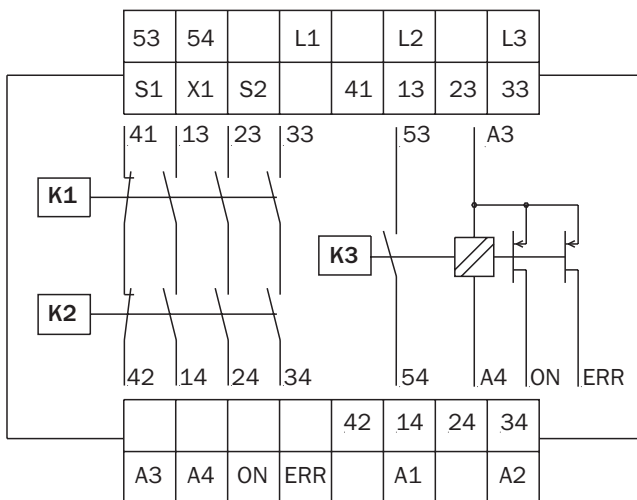

SICK AT A GLANCE

SICK is one of the leading manufacturers of intelligent sensors and sensor solutions for industrial applications. A unique range of products and services creates the perfect basis for controlling processes securely and efficiently, protecting individuals from accidents and preventing damage to the environment.

We have extensive experience in a wide range of industries and understand their processes and requirements. With intelligent sensors, we can deliver exactly what our customers need. In application centers in Europe, Asia and North America, system solutions are tested and optimized in accordance with customer specifications. All this makes us a reliable supplier and development partner.

Comprehensive services complete our offering: SICK LifeTime Services provide support throughout the machine life cycle and ensure safety and productivity.

For us, that is “Sensor Intelligence.”

WORLDWIDE PRESENCE:

Contacts and other locations –www.sick.com