



DSL-1204-G02MNI

SICK
Sensor Intelligence.



Ordering information

Type	Part no.
DSL-1204-G02MNI	6052630

Other models and accessories → www.sick.com/



Detailed technical data

Technical specifications

Accessory group	Plug connectors and cables
Accessory family	Connection cables
Connection type head A	Female connector, M12, 4-pin, straight
Connection type head B	Male connector, M12, 4-pin, straight
Connector material	PUR
Connector color	Gray
Locking nut material	Stainless steel (V4A/1.4404)
Tightening torque	0.6 Nm
Width across flats	14
Cable	2 m, 4-wire, PVC
Jacket material	PVC
Jacket color	Gray
Cable diameter	5 mm
Conductor cross-section	0.34 mm ²
Shielding	Unshielded
Bending radius	
	Flexible use > 10 x cable diameter
	Stationary position > 5 x cable diameter
Reference voltage	≤ 250 V
Rated impulse voltage	2.5 kV
Current loading	4 A
Signal type	Sensor/actuator cable
Application	Hygienic and washdown zones
Note	This product is generally resistant to chemical cleaning agents (see ECOLAB). Please do not use cleaning agents of any other kind. ¹⁾ Not resistant against lactic acid & hydrogen peroxide (H2O2) ²⁾
Authorizations	Ecolab UL

¹⁾ Tested detergent: 3% P3 – topax 990, 5% P3 – topoactive 200, 5% P3 – topax 52, 3% P3 – topax 66, 3% P3 – topoactive OKTO; Insulating material group: Cat I.

²⁾ Insulating material group: Cat I.

UL File No.	CYJV.E335179
Enclosure rating	IP65/ IP67/ IP69K
Ambient operating temperature	
Flexible use	-5 °C ... +80 °C
Stationary position	-30 °C ... +80 °C
Head	-25 °C ... +80 °C

- 1) Tested detergent: 3% P3 – topax 990, 5% P3 – topoactive 200, 5% P3 – topax 52, 3% P3 – topax 66, 3% P3 – topactive OKTO; Insulating material group: Cat I.
 2) Insulating material group: Cat I.

Classifications

ECI@ss 5.0	19030312
ECI@ss 5.1.4	19030312
ECI@ss 6.0	27060304
ECI@ss 6.2	27060304
ECI@ss 7.0	27060304
ECI@ss 8.0	27060304
ECI@ss 8.1	27060304
ECI@ss 9.0	27060304
ECI@ss 10.0	27060304
ECI@ss 11.0	27060304
ECI@ss 12.0	27060304
ETIM 5.0	EC000830
ETIM 6.0	EC000830
ETIM 7.0	EC003249
ETIM 8.0	EC003249
UNSPSC 16.0901	26121604

Dimensional drawing (Dimensions in mm (inch))

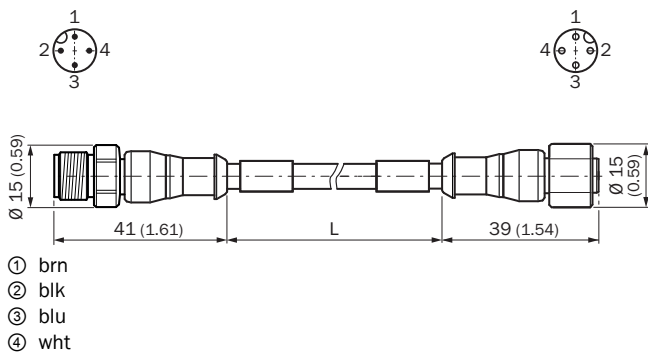

SICK AT A GLANCE

SICK is one of the leading manufacturers of intelligent sensors and sensor solutions for industrial applications. A unique range of products and services creates the perfect basis for controlling processes securely and efficiently, protecting individuals from accidents and preventing damage to the environment.

We have extensive experience in a wide range of industries and understand their processes and requirements. With intelligent sensors, we can deliver exactly what our customers need. In application centers in Europe, Asia and North America, system solutions are tested and optimized in accordance with customer specifications. All this makes us a reliable supplier and development partner.

Comprehensive services complete our offering: SICK LifeTime Services provide support throughout the machine life cycle and ensure safety and productivity.

For us, that is “Sensor Intelligence.”

WORLDWIDE PRESENCE:

Contacts and other locations –www.sick.com