



# RT-B1117

ZoneControl

MULTITASK PHOTOELECTRIC SENSORS

**SICK**  
Sensor Intelligence.



Illustration may differ



## Ordering information

Type	Part no.
RT-B1117	1063153

Other models and accessories → [www.sick.com/ZoneControl](http://www.sick.com/ZoneControl)

## Detailed technical data

### Features

<b>Device type</b>	Photoelectric sensors
<b>Sensor/ detection principle</b>	Photoelectric proximity sensor, Background suppression
<b>Dimensions (W x H x D)</b>	20.6 mm x 99.2 mm x 48.9 mm
<b>Sensing range max.</b>	60 mm ... 900 mm
<b>Sensing range</b>	60 mm ... 900 mm
<b>Focus</b>	7°
<b>Type of light</b>	Infrared light
<b>Light source</b>	LED <sup>1)</sup>
<b>Light spot size (distance)</b>	Ø 20 mm (500 mm)
<b>Angle of dispersion</b>	7°
<b>Adjustment</b>	Potentiometer, 9 turns
<b>Special applications</b>	ZoneControl

<sup>1)</sup> Average service life: 100,000 h at T<sub>J</sub> = +25 °C.

### Mechanics/electronics

<b>Supply voltage</b>	10 V DC ... 30 V DC <sup>1)</sup>
<b>Ripple</b>	< 5 V <sub>pp</sub> <sup>2)</sup>
<b>Current consumption</b>	20 mA <sup>3)</sup>

<sup>1)</sup> Limit values.

<sup>2)</sup> May not exceed or fall below U<sub>v</sub> tolerances.

<sup>3)</sup> Without load and valve deenergized.

<sup>4)</sup> Do not bend below 0 °C.

<sup>5)</sup> A = V<sub>S</sub> connections reverse-polarity protected.

<sup>6)</sup> C = interference suppression.

<sup>7)</sup> D = outputs overcurrent and short-circuit protected.

<b>Switching output</b>	PNP NPN
<b>Switching mode</b>	Light switching
<b>Signal voltage PNP HIGH/LOW</b>	Approx. $V_S - 0.5 \text{ V} / 0 \text{ V}$
<b>Signal voltage NPN HIGH/LOW</b>	Approx. $V_S / < 2.0 \text{ V}$
<b>Output current <math>I_{\text{max}}</math></b>	$\leq 100 \text{ mA}$
<b>Response time</b>	2 ms
<b>Switching frequency</b>	250 Hz
<b>Connection type</b>	Cable, 4-wire, 2 m <sup>4)</sup>
<b>Circuit protection</b>	A <sup>5)</sup> C <sup>6)</sup> D <sup>7)</sup>
<b>Protection class</b>	III
<b>Weight</b>	175 g
<b>Housing material</b>	Plastic, ABS
<b>Enclosure rating</b>	IP67
<b>Shock and vibration resistance</b>	According to IEC 68
<b>Ambient operating temperature</b>	-40 °C ... +60 °C
<b>Ambient temperature, storage</b>	-40 °C ... +75 °C
<b>UL File No.</b>	NRKH.E189383 & NRKH7.E189383

1) Limit values.

2) May not exceed or fall below  $U_V$  tolerances.

3) Without load and valve deenergized.

4) Do not bend below 0 °C.

5) A =  $V_S$  connections reverse-polarity protected.

6) C = interference suppression.

7) D = outputs overcurrent and short-circuit protected.

### Safety-related parameters

<b>MTTF<sub>D</sub></b>	1,525 years
<b>DC<sub>avg</sub></b>	0 %

### Classifications

<b>ECl@ss 5.0</b>	27270904
<b>ECl@ss 5.1.4</b>	27270904
<b>ECl@ss 6.0</b>	27270904
<b>ECl@ss 6.2</b>	27270904
<b>ECl@ss 7.0</b>	27270904
<b>ECl@ss 8.0</b>	27270904
<b>ECl@ss 8.1</b>	27270904
<b>ECl@ss 9.0</b>	27270904
<b>ECl@ss 10.0</b>	27270904
<b>ECl@ss 11.0</b>	27270904
<b>ETIM 5.0</b>	EC002719
<b>ETIM 6.0</b>	EC002719

<b>ETIM 7.0</b>	EC002719
<b>ETIM 8.0</b>	EC002719
<b>UNSPSC 16.0901</b>	39121528

## Connection diagram

Cd-251

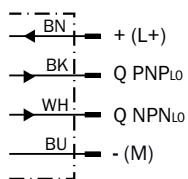

PIN assignment

	Rx-BY11x	B = PNP / NPN
<b>Y</b>	blk	wht
<b>1</b>	QP <sub>Lo</sub>	QN <sub>Lo</sub>
<b>2</b>	QP <sub>Do</sub>	QN <sub>Do</sub>

PIN assignment diagram:

- brn: + (L+)
- blk: See Y
- wht: See Y
- blu: 0 VDC

## Characteristic curve

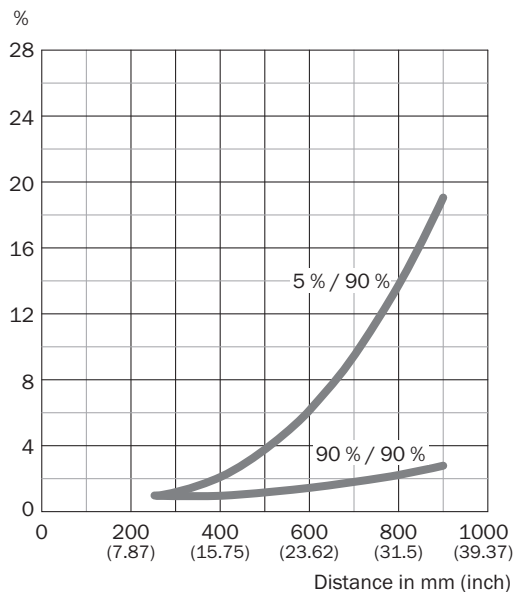

### Light spot size

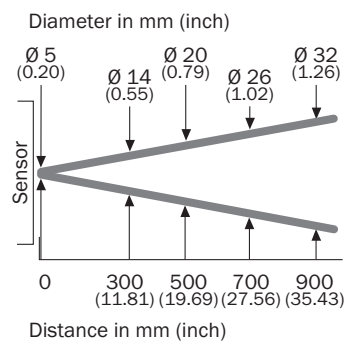

### Dimensional drawing (Dimensions in mm (inch))

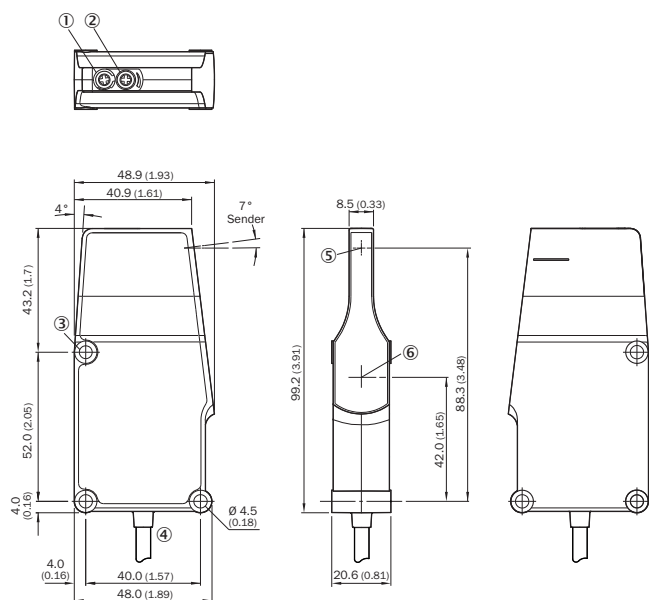

R cable



- ① LED
- ② Potentiometer
- ③ Fixing hole
- ④ Cable
- ⑤ Center of optical axis, sender
- ⑥ Center of optical axis, receiver

Recommended accessories

Other models and accessories → [www.sick.com/ZoneControl](http://www.sick.com/ZoneControl)

	Brief description	Type	Part no.
<b>Mounting brackets and plates</b>			
	Mounting bracket, steel, zinc coated, mounting hardware included	BEF-WK-WTR	2051786
		BEF-WN-RT/IRT	2074621
<b>Plug connectors and cables</b>			
	Head A: male connector, M12, 4-pin, straight Head B: - Cable: unshielded	STE-1204-G	6009932

## SICK AT A GLANCE

SICK is one of the leading manufacturers of intelligent sensors and sensor solutions for industrial applications. A unique range of products and services creates the perfect basis for controlling processes securely and efficiently, protecting individuals from accidents and preventing damage to the environment.

We have extensive experience in a wide range of industries and understand their processes and requirements. With intelligent sensors, we can deliver exactly what our customers need. In application centers in Europe, Asia and North America, system solutions are tested and optimized in accordance with customer specifications. All this makes us a reliable supplier and development partner.

Comprehensive services complete our offering: SICK LifeTime Services provide support throughout the machine life cycle and ensure safety and productivity.

For us, that is “Sensor Intelligence.”

## WORLDWIDE PRESENCE:

Contacts and other locations –[www.sick.com](http://www.sick.com)