



WSE4S-3P3230V

W4

MINIATURE PHOTOELECTRIC SENSORS

SICK
Sensor Intelligence.



Illustration may differ



Ordering information

Type	Part no.
WSE4S-3P3230V	1061108

Other models and accessories → www.sick.com/W4

Detailed technical data

Features

Functional principle	Through-beam photoelectric sensor
Sensing range max.	0 m ... 5 m
Sensing range	0 m ... 4.5 m
Emitted beam	
Light source	PinPoint LED ¹⁾
Type of light	Visible red light
Light spot size (distance)	Ø 50 mm (2 m)
Key LED figures	
Wave length	650 nm
Adjustment	None
Special applications	Hygienic and washdown zones
Part number of individual components	2066762 WS4S-3D3230V 2066763 WE4S-3P3230V
Housing design	Washdown

¹⁾ Average service life: 100,000 h at T_J = +25 °C.

Safety-related parameters

MTTF_D	968 years
DC_{avg}	0 %
T_M (mission time)	20 years

Electronics

Supply voltage U_B	10 V DC ... 30 V DC ¹⁾
Ripple	< 5 V _{pp} ²⁾
Protection class	III
Digital output	
Type	PNP
Switching mode	Light switching
Output current I_{max}	≤ 100 mA
Response time	< 0.5 ms ³⁾
Switching frequency	1,000 Hz ⁴⁾
Circuit protection	A ⁵⁾ B ⁶⁾ C ⁷⁾
Test input sender off	TE to 0 V

¹⁾ Limit values, reverse-polarity protected, operation in short-circuit protected network: max. 8 A.

²⁾ May not fall below or exceed U_Y tolerances.

³⁾ Signal transit time with resistive load.

⁴⁾ With light/dark ratio 1:1.

⁵⁾ A = V_S connections reverse-polarity protected.

⁶⁾ B = inputs and output reverse-polarity protected.

⁷⁾ C = interference suppression.

Mechanics

Housing	Rectangular
Design detail	Slim
Dimensions (W x H x D)	15.25 mm x 49.2 mm x 22.2 mm
Connection	Cable with M8 male connector, 4-pin ^{1) 2)}
Connection detail	
Length of cable (L)	150 mm ²⁾
Material	
Housing	Metal, Stainless steel V4A (1.4404, 316L)
Front screen	Plastic, PMMA
Cable	Plastic, PVC
Weight	50 g

¹⁾ Max. tightening torque: 0.6 Nm.

²⁾ Do not bend below 0 °C.

Ambient data

Enclosure rating	IP66 IP67 IP68 IP69K
Ambient operating temperature	-30 °C ... +70 °C ¹⁾
Ambient temperature, storage	-30 °C ... +75 °C

¹⁾ At $U_V \leq 24$ V and $I_A < 30$ mA.

UL File No.	NRKH.E181493 & NRKH7.E181493
--------------------	------------------------------

¹⁾ At UV ≤ 24 V and IA < 30 mA.

Classifications

ECLASS 5.0	27270901
ECLASS 5.1.4	27270901
ECLASS 6.0	27270901
ECLASS 6.2	27270901
ECLASS 7.0	27270901
ECLASS 8.0	27270901
ECLASS 8.1	27270901
ECLASS 9.0	27270901
ECLASS 10.0	27270901
ECLASS 11.0	27270901
ECLASS 12.0	27270901
ETIM 5.0	EC002716
ETIM 6.0	EC002716
ETIM 7.0	EC002716
ETIM 8.0	EC002716
UNSPSC 16.0901	39121528

Connection diagram

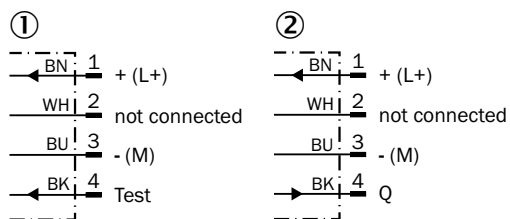

Characteristic curve

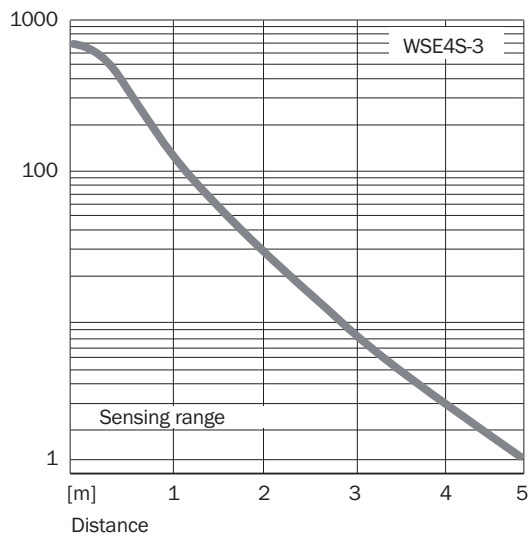

Sensing range diagram

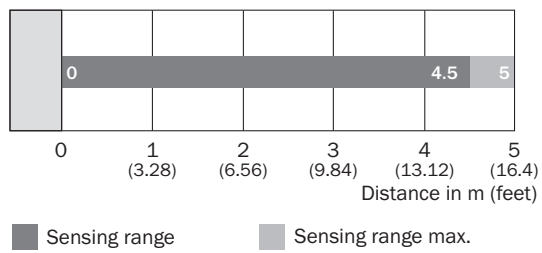

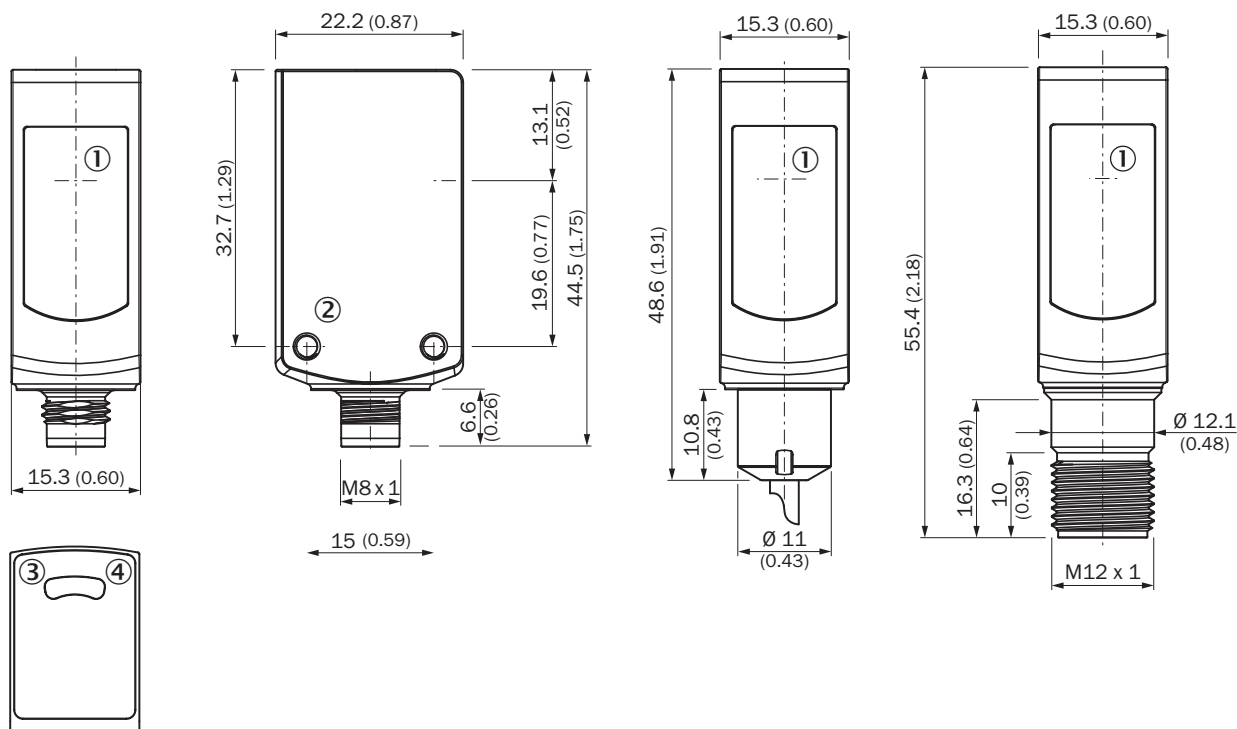

Dimensional drawing (Dimensions in mm (inch))



Recommended accessories

Other models and accessories → www.sick.com/W4

	Brief description	Type	Part no.
Mounting brackets and plates			
	<ul style="list-style-type: none"> Description: Mounting bracket for floor mounting Material: Stainless steel Details: Stainless steel 1.4571 Items supplied: Mounting hardware included Suitable for: W4S, W4F, W4S 	BEF-W4-B	2051630
Others			
	<ul style="list-style-type: none"> Connection type head A: Female connector, M8, 4-pin, straight, A-coded Connection type head B: Flying leads Signal type: Sensor/actuator cable Cable: 5 m, 4-wire, PVC Description: Sensor/actuator cable, unshielded Application: Zones with chemicals, Uncontaminated zones 	YF8U14-050VA3XLEAX	2095889
	<ul style="list-style-type: none"> Connection type head A: Male connector, M8, 4-pin, straight, A-coded Description: Unshielded Connection systems: Screw-type terminals Permitted cross-section: 0.14 mm² ... 0.5 mm² 	STE-0804-G	6037323

SICK AT A GLANCE

SICK is one of the leading manufacturers of intelligent sensors and sensor solutions for industrial applications. A unique range of products and services creates the perfect basis for controlling processes securely and efficiently, protecting individuals from accidents and preventing damage to the environment.

We have extensive experience in a wide range of industries and understand their processes and requirements. With intelligent sensors, we can deliver exactly what our customers need. In application centers in Europe, Asia and North America, system solutions are tested and optimized in accordance with customer specifications. All this makes us a reliable supplier and development partner.

Comprehensive services complete our offering: SICK LifeTime Services provide support throughout the machine life cycle and ensure safety and productivity.

For us, that is “Sensor Intelligence.”

WORLDWIDE PRESENCE:

Contacts and other locations –www.sick.com