



# A3M60A-BBPB014x17

A3M60

**ABSOLUTE ENCODERS**

**SICK**  
Sensor Intelligence.



Illustration may differ



### Ordering information

Type	Part no.
A3M60A-BBPB014x17	1053330

Other models and accessories → [www.sick.com/A3M60](http://www.sick.com/A3M60)

### Detailed technical data

#### Performance

<b>Number of steps per revolution (max. resolution)</b>	16,384 (14 bit)
<b>Number of revolutions</b>	131,072 (17 bit)
<b>Max. resolution (number of steps per revolution x number of revolutions)</b>	14 bit x 17 bit (16,384 x 131,072)
<b>Error limits G</b>	0.35° (at room temperature) <sup>1)</sup>
<b>Repeatability standard deviation <math>\sigma_r</math></b>	0.15° (at room temperature) <sup>2)</sup>

<sup>1)</sup> In accordance with DIN ISO 1319-1, position of the upper and lower error limit depends on the installation situation, specified value refers to a symmetrical position, i.e. deviation in upper and lower direction is the same.

<sup>2)</sup> In accordance with DIN ISO 55350-13; 68.3% of the measured values are inside the specified area.

#### Interfaces

<b>Communication interface</b>	PROFIBUS DP
<b>Communication Interface detail</b>	DPV0 DPV1 DPV2
<b>Data transmission rate (baud rate)</b>	≤ 12 MBaud
<b>Initialization time</b>	Approx. 1 s
<b>Parameterising data</b>	Number of steps per revolution Number of revolutions PRESET Counting direction Unit for output of the speed value Round axis functionality
<b>Available diagnostics data</b>	Maximum speed Power-on counter Operating hour counter Minimum and maximum operating voltage
<b>Bus termination</b>	DIP switch

#### Electrical data

<b>Connection type</b>	Male connector, 2x, M12, 5-pin, axial Female connector, 1x, M12, 5-pin, axial
------------------------	----------------------------------------------------------------------------------

<sup>1)</sup> This product is a standard product and does not constitute a safety component as defined in the Machinery Directive. Calculation based on nominal load of components, average ambient temperature 40°C, frequency of use 8760 h/a. All electronic failures are considered hazardous. For more information, see document no. 8015532.

<b>Supply voltage</b>	10 ... 32 V
<b>Power consumption</b>	≤ 1.5 W
<b>Reverse polarity protection</b>	✓
<b>MTTFd: mean time to dangerous failure</b>	60 years (EN ISO 13849-1) <sup>1)</sup>

<sup>1)</sup> This product is a standard product and does not constitute a safety component as defined in the Machinery Directive. Calculation based on nominal load of components, average ambient temperature 40 °C, frequency of use 8760 h/a. All electronic failures are considered hazardous. For more information, see document no. 8015532.

## Mechanical data

<b>Mechanical design</b>	Blind hollow shaft
<b>Shaft diameter</b>	8 mm
<b>Weight</b>	0.28 kg
<b>Shaft material</b>	Stainless steel
<b>Flange material</b>	Aluminum
<b>Housing material</b>	Aluminum
<b>Start up torque</b>	2 Ncm (+20 °C)
<b>Operating torque</b>	1.6 Ncm (+20 °C)
<b>Permissible movement static</b>	± 0.3 mm (radial) ± 0.5 mm (axial)
<b>Permissible movement dynamic</b>	± 0.1 mm (radial) ± 0.2 mm (axial)
<b>Operating speed</b>	≤ 6,000 min <sup>-1</sup> <sup>1)</sup>
<b>Bearing lifetime</b>	3.0 x 10 <sup>9</sup> revolutions
<b>Angular acceleration</b>	≤ 500,000 rad/s <sup>2</sup>

<sup>1)</sup> Self warming 35 K at maximum operating speed.

## Ambient data

<b>EMC</b>	According to EN 61000-6-2 and EN 61000-6-3
<b>Enclosure rating</b>	IP67, shaft side (IEC 60529) IP67, housing side (IEC 60529) <sup>1)</sup>
<b>Permissible relative humidity</b>	95 % (Condensation not permitted)
<b>Operating temperature range</b>	-30 °C ... +80 °C
<b>Storage temperature range</b>	-40 °C ... +100 °C
<b>Resistance to shocks</b>	100 g, 6 ms (EN 60068-2-27)
<b>Resistance to vibration</b>	30 g, 10 Hz ... 2,000 Hz (EN 60068-2-6)

<sup>1)</sup> With mating connector fitted.

## Classifications

<b>eCl@ss 5.0</b>	27270502
<b>eCl@ss 5.1.4</b>	27270502
<b>eCl@ss 6.0</b>	27270590
<b>eCl@ss 6.2</b>	27270590
<b>eCl@ss 7.0</b>	27270502
<b>eCl@ss 8.0</b>	27270502
<b>eCl@ss 8.1</b>	27270502

<b>eCl@ss 9.0</b>	27270502
<b>eCl@ss 10.0</b>	27270502
<b>eCl@ss 11.0</b>	27270502
<b>eCl@ss 12.0</b>	27270502
<b>ETIM 5.0</b>	EC001486
<b>ETIM 6.0</b>	EC001486
<b>ETIM 7.0</b>	EC001486
<b>ETIM 8.0</b>	EC001486
<b>UNSPSC 16.0901</b>	41112113

### Dimensional drawing (Dimensions in mm (inch))

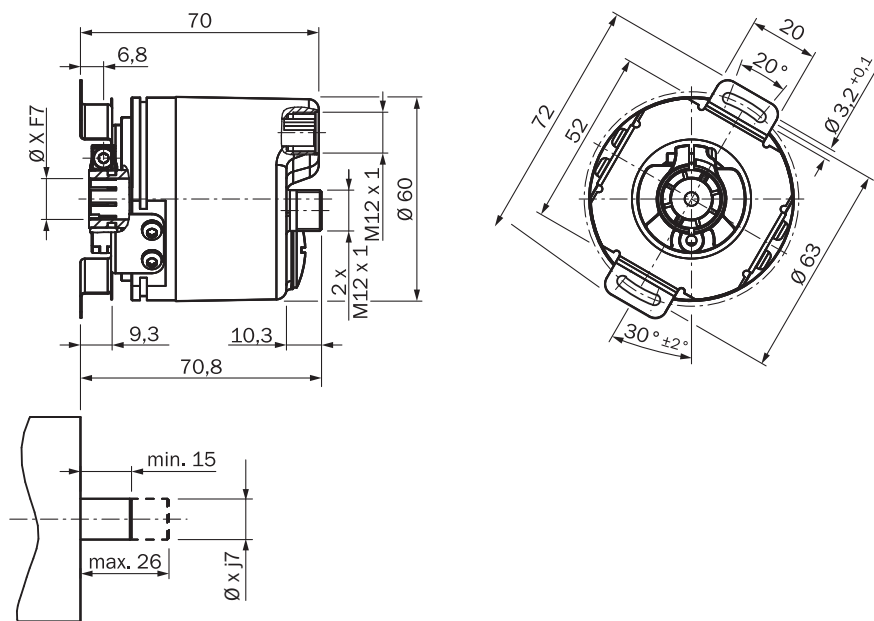

### PIN assignment

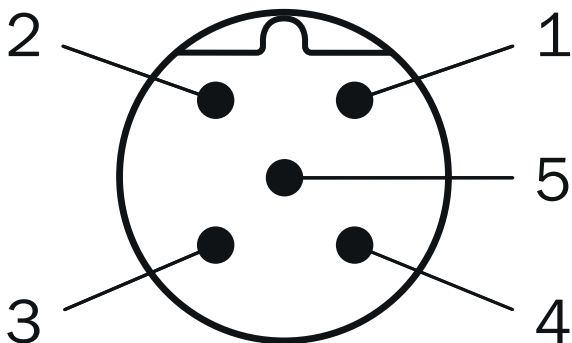

PIN	PROFIBUS IN	PROFIBUS OUT	Supply voltage
1	Not assigned	+5 V 2P5 1)	Operating voltage
2	PROFIBUS Data A	PROFIBUS Data A	Not assigned
3	Not assigned	0 V (2M) <sup>1)</sup>	Ground (0 V)
4	PROFIBUS Data B	PROFIBUS Data B	Not assigned
5	Screen	Screen	Not assigned
1) External connection to the bus			

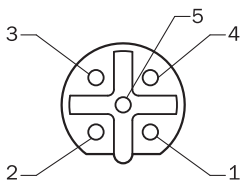

PIN	PROFIBUS IN	PROFIBUS OUT	Supply voltage
1	Not assigned	+5 V 2P5 1)	Operating voltage
2	PROFIBUS Data A	PROFIBUS Data A	Not assigned
3	Not assigned	0 V (2M) <sup>1)</sup>	Ground (0 V)
4	PROFIBUS Data B	PROFIBUS Data B	Not assigned
5	Screen	Screen	Not assigned
1) External connection to the bus			

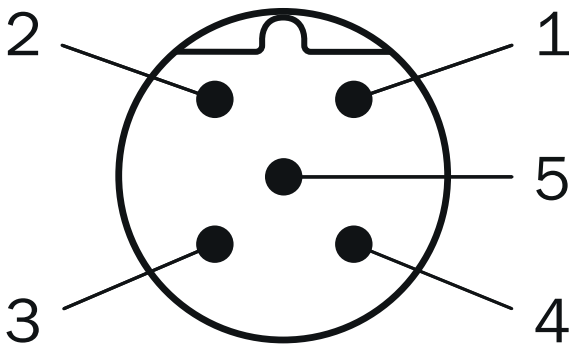











PIN	PROFIBUS IN	PROFIBUS OUT	Supply voltage
1	Not assigned	+5 V 2P5	Operating voltage

PIN	PROFIBUS IN	PROFIBUS OUT	Supply voltage
		1)	
2	PROFIBUS Data A	PROFIBUS Data A	Not assigned
3	Not assigned	0 V (2M) <sup>1)</sup>	Ground (0 V)
4	PROFIBUS Data B	PROFIBUS Data B	Not assigned
5	Screen	Screen	Not assigned
1) External connection to the bus			

### Recommended accessories

Other models and accessories → [www.sick.com/A3M60](http://www.sick.com/A3M60)

	Brief description	Type	Part no.
<b>Plug connectors and cables</b>			
	Head A: Flying leads Head B: Flying leads Cable: PROFIBUS DP, PUR, shielded	LTG-2102-MW	6021355
	Head A: female connector, M12, 5-pin, angled, A-coded Head B: Flying leads Cable: Sensor/actuator cable, PUR, halogen-free, unshielded, 5 m Voltage supply	DOL-1202-W05MC	6042067
	Head A: female connector, M12, 5-pin, angled, A-coded Head B: Flying leads Cable: Sensor/actuator cable, PUR, halogen-free, unshielded, 10 m Voltage supply	DOL-1202-W10MC	6042068
	Head A: female connector, M12, 5-pin, straight, B-coded Head B: Flying leads Cable: PROFIBUS DP, twisted pair, PUR, halogen-free, shielded, 5 m	DOL-1205-G05MQ	6026006
	Head A: female connector, M12, 5-pin, straight, B-coded Head B: Flying leads Cable: PROFIBUS DP, twisted pair, PUR, halogen-free, shielded, 10 m	DOL-1205-G10MQ	6026008
	Head A: female connector, M12, 5-pin, angled, B-coded Head B: Flying leads Cable: PROFIBUS DP, twisted pair, PUR, halogen-free, shielded, 5 m	DOL-1205-W05MQ	6041423
	Head A: female connector, M12, 5-pin, angled, B-coded Head B: Flying leads Cable: PROFIBUS DP, twisted pair, PUR, halogen-free, shielded, 10 m	DOL-1205-W10MQ	6041425
	Head A: male connector, M12, 5-pin, straight, B-coded Head B: Flying leads Cable: PROFIBUS DP, twisted pair, PUR, halogen-free, shielded, 5 m Wire shield Al-Pt film, overall shield C-screen tin-plated	STL-1205-G05MQ	6026005
	Head A: male connector, M12, 5-pin, straight, B-coded Head B: Flying leads Cable: PROFIBUS DP, twisted pair, PUR, halogen-free, shielded, 10 m Wire shield Al-Pt film, overall shield C-screen tin-plated	STL-1205-G10MQ	6026007

	Brief description	Type	Part no.
	Head A: male connector, M12, 5-pin, angled, B-coded Head B: Flying leads Cable: PROFIBUS DP, twisted pair, PUR, halogen-free, shielded, 5 m	STL-1205-W05MQ	6041426
	Head A: male connector, M12, 5-pin, angled, B-coded Head B: Flying leads Cable: PROFIBUS DP, twisted pair, PUR, halogen-free, shielded, 10 m	STL-1205-W10MQ	6041427
	Head A: female connector, M12, 5-pin, straight, A-coded Head B: Flying leads Cable: Sensor/actuator cable, PUR, halogen-free, shielded, 5 m	YF2A25-050UB6XLEAX	2095733
	Head A: female connector, M12, 5-pin, straight, A-coded Head B: Flying leads Cable: Sensor/actuator cable, PUR, halogen-free, shielded, 10 m	YF2A25-100UB6XLEAX	2095734
	Head A: female connector, M12, 5-pin, straight, A-coded Head B: Flying leads Cable: Sensor/actuator cable, PUR, halogen-free, shielded, 20 m	YF2A25-200UB6XLEAX	2095738
	Head A: female connector, M12, 5-pin, straight, B-coded Head B: male connector, M12, 5-pin, straight, B-coded Cable: PROFIBUS DP, twisted pair, PUR, halogen-free, shielded, 10 m Wire shield Al-Pt film, overall shield C-screen tin-plated	DSL-1205-G10MQ	6032640
	Head A: female connector, M12, 5-pin, straight Cable: unshielded	DOS-1205-G	6009719
	Head A: female connector, M12, 5-pin, straight, B-coded Cable: PROFIBUS DP, shielded	DOS-1205-GQ	6021353
	Head A: female connector, M12, 5-pin, angled Cable: unshielded	DOS-1205-W	6009720
	Head A: female connector, M12, 5-pin, angled, B-coded (B-inverse) Cable: PROFIBUS DP, PROFIBUS DP, shielded	DOS-1205-WQ	6041429
	Head A: male connector, M12, 5-pin, straight, B-coded Cable: PROFIBUS DP, shielded	STE-1205-GQ	6021354
	Head A: male connector, M12, 5-pin, angled, B-coded Cable: PROFIBUS DP, shielded	STE-1205-WQ	6041428
	Cable: unshielded, set of connectors	DOS-3XM12-W	2058177
	Head A: male connector, M12, 4-pin, straight, B-coded Cable: PROFIBUS DP, terminal resistor	STE-END-Q	6021156

## SICK AT A GLANCE

SICK is one of the leading manufacturers of intelligent sensors and sensor solutions for industrial applications. A unique range of products and services creates the perfect basis for controlling processes securely and efficiently, protecting individuals from accidents and preventing damage to the environment.

We have extensive experience in a wide range of industries and understand their processes and requirements. With intelligent sensors, we can deliver exactly what our customers need. In application centers in Europe, Asia and North America, system solutions are tested and optimized in accordance with customer specifications. All this makes us a reliable supplier and development partner.

Comprehensive services complete our offering: SICK LifeTime Services provide support throughout the machine life cycle and ensure safety and productivity.

For us, that is “Sensor Intelligence.”

## WORLDWIDE PRESENCE:

Contacts and other locations –[www.sick.com](http://www.sick.com)