



RAY26P-34162A30A00

Reflex Array

MULTITASK PHOTOELECTRIC SENSORS

SICK
Sensor Intelligence.



Illustration may differ



Ordering information

Type	Part no.
RAY26P-34162A30A00	1111102

Other models and accessories → www.sick.com/Reflex_Array

Detailed technical data

Features

Device type	Photoelectric sensors
Sensor/ detection principle	Photoelectric retro-reflective sensor, autocollimation Reflex Array
Dimensions (W x H x D)	24.6 mm x 82.5 mm x 53.3 mm
Housing design (light emission)	Rectangular
Minimum object size	10 mm, (factory setting), 15 mm, 20 mm, 25 mm, 30 mm, position-independent detection within the light array, configurable via IO-Link
Detection height	55 mm
Sensing range max.	0 m ... 4.5 m ^{1) 2)}
Distance of the sensor to reflector	≥ 0 m
Type of light	Visible red light
Light source	PinPoint LED ³⁾
Light spot size (distance)	55 mm x 9 mm (1 m)
Wave length	635 nm
Adjustment	BluePilot: Teach-in IO-Link
Pin 2 configuration	External Input (test), Teach-in, switching signal

¹⁾ Reflector PL80A.

²⁾ At minimum object size 10 mm.

³⁾ Average service life: 100,000 h at T_J = +25 °C.

AutoAdapt	✓
Special applications	Detecting objects with position tolerances, Detecting perforated objects, Detecting uneven, shiny objects, Detecting transparent objects, Detecting flat objects

¹⁾ Reflector PL80A.

²⁾ At minimum object size 10 mm.

³⁾ Average service life: 100,000 h at $T_U = +25\text{ °C}$.

Mechanics/electronics

Supply voltage	10 V DC ... 30 V DC ¹⁾
Ripple	< 5 V _{pp}
Current consumption	25 mA ²⁾ 40 mA ³⁾
Switching output	Push-pull: PNP/NPN
Output: Q_{L1} / C	Switching output or IO-Link mode
Output function	Factory setting: Pin 2 / white (MF): NPN normally closed (light switching), PNP normally open (dark switching), Pin 4 / black (QL1 / C): NPN normally open (dark switching), PNP normally closed (light switching), IO-Link
Switching mode	Light/dark switching
Switching mode selector	Via IO-Link
Signal voltage PNP HIGH/LOW	Approx. V _S - 2.5 V / 0 V
Signal voltage NPN HIGH/LOW	Approx. V _S / < 2.5 V
Output current I_{max}	≤ 100 mA
Response time	≤ 500 μs ⁴⁾
Switching frequency	1,000 Hz ⁵⁾
Connection type	Cable with M12 male connector, 4-pin, 270 mm ⁶⁾
Cable material	PVC
Circuit protection	A ⁷⁾ B ⁸⁾ C ⁹⁾ D ¹⁰⁾
Protection class	III
Weight	100 g
Housing material	Plastic, VISTAL®
Optics material	Plastic, PMMA
Enclosure rating	IP66

¹⁾ Limit values.

²⁾ 16 V DC ... 30 V DC, without load.

³⁾ 10 V DC ... 16 V DC, without load.

⁴⁾ Signal transit time with resistive load in switching mode. Different values possible in COM2 mode.

⁵⁾ With light/dark ratio 1:1 in switching mode. Different values possible in IO-Link mode.

⁶⁾ Do not bend below 0 °C.

⁷⁾ A = V_S connections reverse-polarity protected.

⁸⁾ B = inputs and output reverse-polarity protected.

⁹⁾ C = interference suppression.

¹⁰⁾ D = outputs overcurrent and short-circuit protected.

¹¹⁾ Avoid condensation on the front screen of the sensor and on the reflector.

¹²⁾ Allowed temperature change after Teach +/- 20 K.

	IP67
Ambient operating temperature	-40 °C ... +60 °C ¹¹⁾ ¹²⁾
Ambient temperature, storage	-40 °C ... +75 °C
UL File No.	NRKH.E181493 & NRKH7.E181493

¹⁾ Limit values.

²⁾ 16 V DC ... 30 V DC, without load.

³⁾ 10 V DC ... 16 V DC, without load.

⁴⁾ Signal transit time with resistive load in switching mode. Different values possible in COM2 mode.

⁵⁾ With light/dark ratio 1:1 in switching mode. Different values possible in IO-Link mode.

⁶⁾ Do not bend below 0 °C.

⁷⁾ A = V_S connections reverse-polarity protected.

⁸⁾ B = inputs and output reverse-polarity protected.

⁹⁾ C = interference suppression.

¹⁰⁾ D = outputs overcurrent and short-circuit protected.

¹¹⁾ Avoid condensation on the front screen of the sensor and on the reflector.

¹²⁾ Allowed temperature change after Teach +/- 20 K.

Safety-related parameters

MTTF_D	709 years
DC_{avg}	0 %

Communication interface

Communication interface	IO-Link V1.1
Communication Interface detail	COM2 (38,4 kBaud)
Cycle time	2.3 ms
Process data length	16 Bit
Process data structure	Bit 0 = switching signal Q _{L1} Bit 1 = switching signal Q _{L2} Bit 2 ... 15 = empty
VendorID	26
DeviceID HEX	0080026D
DeviceID DEC	8389229

Smart Task

Smart Task name	Base logics
Logic function	Direct AND OR Window Hysteresis
Timer function	Deactivated On delay Off delay ON and OFF delay Impulse (one shot)
Inverter	Yes
Switching frequency	SIO Direct: 1000 Hz ¹⁾ SIO Logic: 800 Hz ²⁾

¹⁾ SIO Direct: sensor operation in standard I/O mode without IO-Link communication and without using internal sensor logic or time parameters (set to "direct"/"deactivated").

²⁾ SIO Logic: Sensor operation in standard I/O mode without IO-Link communication. Sensor-internal logic or timing parameters plus Automation Functions used.

³⁾ IOL: Sensor operation with full IO-Link communication and usage of logic, timing and Automation Function parameters.

Response time	IOL: 650 Hz ³⁾ SIO Direct: 500 µs ¹⁾ SIO Logic: 600 µs ²⁾ IOL: 750 µs ³⁾
Repeatability	SIO Direct: 150 µs ¹⁾ SIO Logic: 300 µs ²⁾ IOL: 400 µs ³⁾
Switching signal	
Switching signal Q _{L1}	Switching output
Switching signal Q _{L2}	Switching output

¹⁾ SIO Direct: sensor operation in standard I/O mode without IO-Link communication and without using internal sensor logic or time parameters (set to "direct"/"deactivated").

²⁾ SIO Logic: Sensor operation in standard I/O mode without IO-Link communication. Sensor-internal logic or timing parameters plus Automation Functions used.

³⁾ IOL: Sensor operation with full IO-Link communication and usage of logic, timing and Automation Function parameters.

Diagnosis

Device status	Yes
Quality of teach	Yes
Quality of run	Yes, Contamination display

Classifications

eCl@ss 5.0	27270902
eCl@ss 5.1.4	27270902
eCl@ss 6.0	27270902
eCl@ss 6.2	27270902
eCl@ss 7.0	27270902
eCl@ss 8.0	27270902
eCl@ss 8.1	27270902
eCl@ss 9.0	27270902
eCl@ss 10.0	27270902
eCl@ss 11.0	27270902
eCl@ss 12.0	27270902
ETIM 5.0	EC002717
ETIM 6.0	EC002717
ETIM 7.0	EC002717
ETIM 8.0	EC002717
UNSPSC 16.0901	39121528

Connection diagram

Cd-390

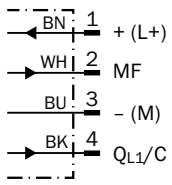

Light spot size

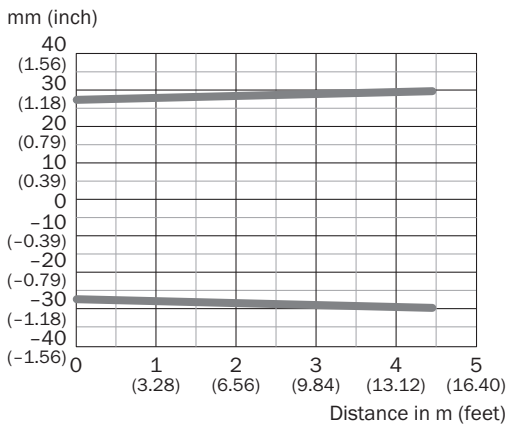

Sensing range diagram

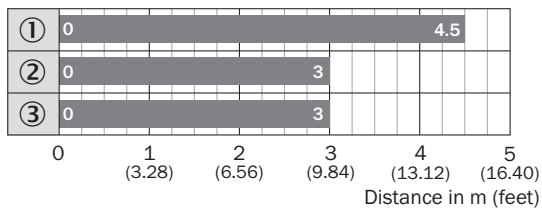

- Sensing range
- ① Reflector PL80A
- ② Reflector PL81
- ③ Reflector PL100

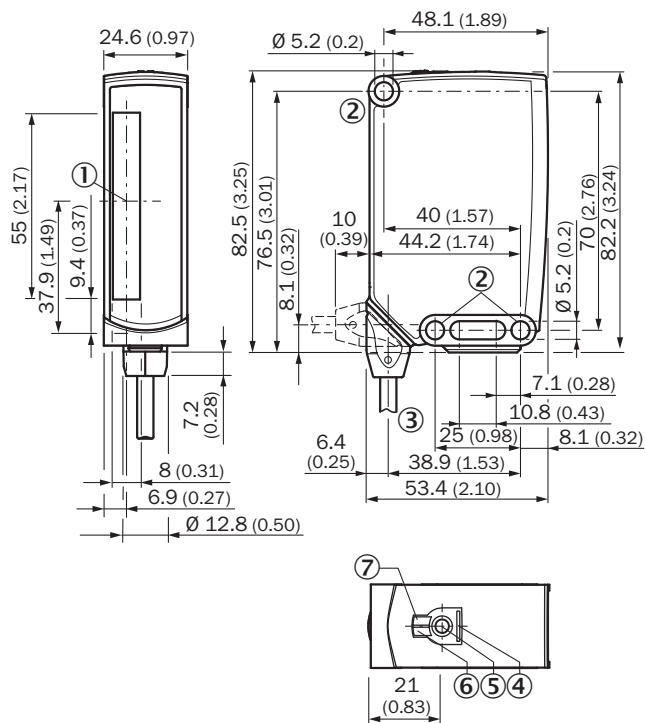

Dimensional drawing (Dimensions in mm (inch))





- ① Center of optical axis
- ② Mounting hole, Ø 5.2 mm
- ③ Connection
- ④ BluePilot blue: AutoAdapt indicator during run mode
- ⑤ Teach-in button
- ⑥ LED indicator yellow: Status of received light beam
- ⑦ LED indicator green: Supply voltage active

Recommended accessories

Other models and accessories → www.sick.com/Reflex_Array

	Brief description	Type	Part no.
Mounting brackets and plates			
	Mounting bracket, steel, zinc coated, mounting hardware included	BEF-WN-W23	2019085
Plug connectors and cables			
	Head A: female connector, M12, 4-pin, straight, A-coded Head B: Flying leads Cable: Sensor/actuator cable, PVC, unshielded, 5 m	YF2A14-050VB3XLEAX	2096235
	Head A: male connector, M12, 4-pin, straight Cable: unshielded	STE-1204-G	6009932

	Brief description	Type	Part no.
Reflectors			
	Rectangular, screw connection, 100 mm x 100 mm, PMMA/ABS, Screw-on, 2 hole mounting	PL100	5321625
	Rectangular, screw connection, 84 mm x 84 mm, PMMA/ABS, Screw-on, 2 hole mounting	PL80A	1003865
	Rectangular, self-adhesive, 50 mm x 80 mm, PMMA/ABS, self-adhesive	PL81	5322795

SICK AT A GLANCE

SICK is one of the leading manufacturers of intelligent sensors and sensor solutions for industrial applications. A unique range of products and services creates the perfect basis for controlling processes securely and efficiently, protecting individuals from accidents and preventing damage to the environment.

We have extensive experience in a wide range of industries and understand their processes and requirements. With intelligent sensors, we can deliver exactly what our customers need. In application centers in Europe, Asia and North America, system solutions are tested and optimized in accordance with customer specifications. All this makes us a reliable supplier and development partner.

Comprehensive services complete our offering: SICK LifeTime Services provide support throughout the machine life cycle and ensure safety and productivity.

For us, that is “Sensor Intelligence.”

WORLDWIDE PRESENCE:

Contacts and other locations –www.sick.com