



# GTB6-P1231

G6

MINIATURE PHOTOELECTRIC SENSORS

**SICK**  
Sensor Intelligence.



Illustration may differ



### Ordering information

| Type       | Part no. |
|------------|----------|
| GTB6-P1231 | 1074135  |

Other models and accessories → [www.sick.com/G6](http://www.sick.com/G6)

### Detailed technical data

#### Features

|                                    |                                |
|------------------------------------|--------------------------------|
| <b>Device type</b>                 | Photoelectric sensors          |
| <b>Functional principle</b>        | Photoelectric proximity sensor |
| <b>Functional principle detail</b> | Background suppression         |
| <b>Sensing range max.</b>          | 5 mm ... 400 mm <sup>1)</sup>  |
| <b>Sensing range</b>               | 50 mm ... 220 mm               |
| <b>Polarisation filters</b>        | No                             |
| <b>Emitted beam</b>                |                                |
| Light source                       | PinPoint LED <sup>2)</sup>     |
| Type of light                      | Visible red light              |
| <b>Light spot size (distance)</b>  | Ø 6 mm (100 mm)                |
| <b>Key LED figures</b>             |                                |
| Wave length                        | 625 nm                         |
| <b>Adjustment</b>                  | Mechanical spindle, 5 turns    |

<sup>1)</sup> Object with 90 % reflectance (referred to standard white, DIN 5033).

<sup>2)</sup> Average service life: 100,000 h at T<sub>U</sub> = +25 °C.

## Electrical data

|  |   |
|--|---|
| <b>Supply voltage <math>U_B</math></b> | 10 V DC ... 30 V DC <sup>1)</sup>                     |
| <b>Ripple</b>                          | $\pm 10\%$ <sup>2)</sup>                              |
| <b>Power consumption</b>               | 32 mA <sup>3)</sup>                                   |
| <b>Protection class</b>                | III   |
| <b>Digital output</b>                  |   |
| Type                                   | PNP   |
| Signal voltage NPN HIGH/LOW            | Approx. $V_S / \leq 3\text{ V}$                       |
| Output current $I_{max}$               | $\leq 100\text{ mA}$ <sup>4)</sup>                    |
| Response time                          | $< 1.2\text{ ms}$ <sup>5)</sup>                       |
| Switching frequency                    | 500 Hz <sup>6)</sup>                                  |
| <b>Switching mode</b>                  | Light/dark switching                                  |
| <b>Switching mode selector</b>         | Selectable via light/dark selector                    |
| <b>Circuit protection</b>              | A <sup>7)</sup><br>B <sup>8)</sup><br>D <sup>9)</sup> |

<sup>1)</sup> Limit values when operated in short-circuit protected network: max. 8 A.

<sup>2)</sup> May not exceed or fall below  $U_V$  tolerances.

<sup>3)</sup> Without load.

<sup>4)</sup> At  $U_V > 24\text{ V}$ ,  $I_A$  max. = 50 mA.

<sup>5)</sup> Signal transit time with resistive load.

<sup>6)</sup> With light/dark ratio 1:1.

<sup>7)</sup> A =  $V_S$  connections reverse-polarity protected.

<sup>8)</sup> B = inputs and output reverse-polarity protected.

<sup>9)</sup> D = outputs overcurrent and short-circuit protected.

## Mechanical data

|                               |                                  |
|-------------------------------|----------------------------------|
| <b>Housing</b>                | Rectangular                      |
| <b>Dimensions (W x H x D)</b> | 12 mm x 31.5 mm x 21 mm          |
| <b>Connection</b>             | Cable, 3-wire, 2 m <sup>1)</sup> |
| <b>Connection detail</b>      |                                  |
| Conductor size                | 0.14 mm <sup>2</sup>             |
| Length of cable               | 2 m                              |
| <b>Material</b>               |                                  |
| Housing                       | Plastic, ABS/PC                  |
| Front screen                  | Plastic, PMMA                    |
| Cable                         | PVC                              |
| <b>Weight</b>                 | 60 g                             |

<sup>1)</sup> Do not bend below 0 °C.

## Ambient data

|                                      |                                 |
|--------------------------------------|---------------------------------|
| <b>Enclosure rating</b>              | IP67                            |
| <b>Ambient operating temperature</b> | -25 °C ... +55 °C <sup>1)</sup> |

<sup>1)</sup> Temperature stability following adjustment +/-10 °C.

|                                     |                              |
|-------------------------------------|------------------------------|
| <b>Ambient temperature, storage</b> | -40 °C ... +70 °C            |
| <b>UL File No.</b>                  | NRKH.E348498 & NRKH7.E348498 |

<sup>1)</sup> Temperature stability following adjustment +/-10 °C.

### Classifications

|                       |          |
|-----------------------|----------|
| <b>ECl@ss 5.0</b>     | 27270904 |
| <b>ECl@ss 5.1.4</b>   | 27270904 |
| <b>ECl@ss 6.0</b>     | 27270904 |
| <b>ECl@ss 6.2</b>     | 27270904 |
| <b>ECl@ss 7.0</b>     | 27270904 |
| <b>ECl@ss 8.0</b>     | 27270904 |
| <b>ECl@ss 8.1</b>     | 27270904 |
| <b>ECl@ss 9.0</b>     | 27270904 |
| <b>ECl@ss 10.0</b>    | 27270904 |
| <b>ECl@ss 11.0</b>    | 27270904 |
| <b>ETIM 5.0</b>       | EC002719 |
| <b>ETIM 6.0</b>       | EC002719 |
| <b>ETIM 7.0</b>       | EC002719 |
| <b>ETIM 8.0</b>       | EC002719 |
| <b>UNSPSC 16.0901</b> | 39121528 |

### Connection type

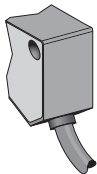

### Connection diagram

Cd-043

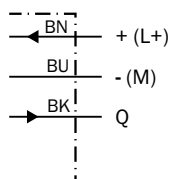

### Characteristic curve

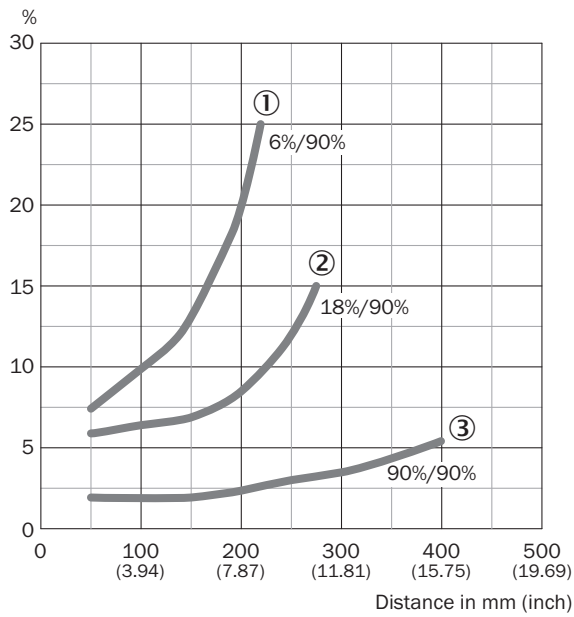

- ① Sensing range on black, 6% remission
- ② Sensing range on gray, 18 % remission
- ③ Object with 90% remission (based on standard white DIN 5033)

### Light spot size

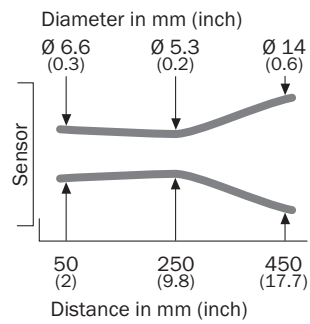

### Sensing range diagram

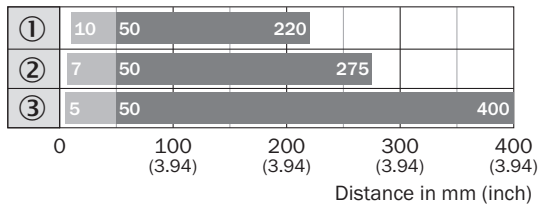

■ Sensing range                      ■ Sensing range max. typ.

- ① Sensing range on black, 6 % remission
- ② Sensing range on grey, 18 % remission
- ③ Sensing range on white, 90 % Remission

### Adjustments

Adjustment possibility

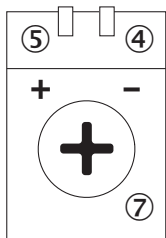

- ④ LED indicator green: Supply voltage active
- ⑤ LED indicator yellow: Status of received light beam
- ⑦ Sensitivity control: potentiometer

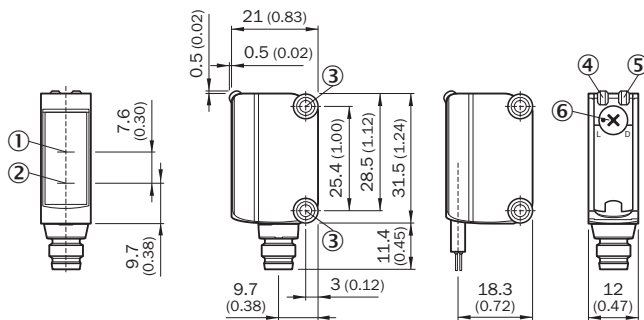

### Dimensional drawing (Dimensions in mm (inch))



- ① Optical axis, receiver
- ② Optical axis, sender
- ③ Mounting holes M3
- ④ LED indicator green: Supply voltage active
- ⑤ LED indicator yellow: Status of received light beam
- ⑥ Light/ dark rotary switch: L = light switching, D = dark switching

## Recommended accessories

Other models and accessories → [www.sick.com/G6](http://www.sick.com/G6)

|   | Brief description   | Type       | Part no. |
|---|---|------------|----------|
| Mounting brackets and plates  |   |            |          |
|  | Stainless steel (1.4301)  | BEF-WN-G6  | 2062909  |
| Plug connectors and cables  |   |            |          |
|  | Head A: male connector, M8, 3-pin, straight<br>Head B: -<br>Cable: unshielded | STE-0803-G | 6037322  |

## SICK AT A GLANCE

SICK is one of the leading manufacturers of intelligent sensors and sensor solutions for industrial applications. A unique range of products and services creates the perfect basis for controlling processes securely and efficiently, protecting individuals from accidents and preventing damage to the environment.

We have extensive experience in a wide range of industries and understand their processes and requirements. With intelligent sensors, we can deliver exactly what our customers need. In application centers in Europe, Asia and North America, system solutions are tested and optimized in accordance with customer specifications. All this makes us a reliable supplier and development partner.

Comprehensive services complete our offering: SICK LifeTime Services provide support throughout the machine life cycle and ensure safety and productivity.

For us, that is “Sensor Intelligence.”

## WORLDWIDE PRESENCE:

Contacts and other locations –[www.sick.com](http://www.sick.com)