



WSE2S-2P3230S04

W2S-2

MINIATURE PHOTOELECTRIC SENSORS

SICK
Sensor Intelligence.



Illustration may differ



Ordering information

Type	Part no.
WSE2S-2P3230S04	1086969

Other models and accessories → www.sick.com/W2S-2

Detailed technical data

Features

Device type	Photoelectric sensors
Sensor/ detection principle	Through-beam photoelectric sensor
Dimensions (W x H x D)	7.7 mm x 21.8 mm x 13.5 mm
Housing design (light emission)	Rectangular
Sensing range max.	0 m ... 2.5 m
Sensing range	0 m ... 2 m
Type of light	Visible red light
Light source	PinPoint LED ¹⁾
Light spot size (distance)	Ø 65 mm (1,500 mm)
Wave length	640 nm
Adjustment	None
Special features	Increased operating reserve

¹⁾ Average service life: 100,000 h at T_U = +25 °C.

Mechanics/electronics

Supply voltage	10 V DC ... 30 V DC ¹⁾
Ripple	< 5 V _{pp} ²⁾
Current consumption	20 mA ³⁾
Switching output	PNP
Switching mode	Light/dark switching
Output current I_{max.}	≤ 50 mA
Response time	< 0.4 ms ⁴⁾
Switching frequency	1,200 Hz ⁵⁾
Connection type	Cable with M8 male connector, 4-pin, 200 mm ⁶⁾
Cable material	PVC
Cable diameter	Ø 3 mm
Circuit protection	A ⁷⁾ B ⁸⁾ D ⁹⁾
Housing material	Plastic, ABS/PC
Optics material	Plastic, PMMA
Enclosure rating	IP67
Ambient operating temperature	-25 °C ... +50 °C
Ambient temperature, storage	-40 °C ... +75 °C
UL File No.	NRKH.E181493
Part number of individual components	2069152 WS2S-2D3230 2069153 WE2S-2P3230

- 1) Limit values.
- 2) May not exceed or fall below U_v tolerances.
- 3) Without load.
- 4) Signal transit time with resistive load.
- 5) With light/dark ratio 1:1.
- 6) Do not bend below 0 °C.
- 7) A = V_S connections reverse-polarity protected.
- 8) B = output reverse-polarity protected.
- 9) D = outputs overcurrent and short-circuit protected.

Classifications

ECl@ss 5.0	27270901
ECl@ss 5.1.4	27270901
ECl@ss 6.0	27270901
ECl@ss 6.2	27270901
ECl@ss 7.0	27270901
ECl@ss 8.0	27270901
ECl@ss 8.1	27270901
ECl@ss 9.0	27270901
ECl@ss 10.0	27270901
ECl@ss 11.0	27270901
ETIM 5.0	EC002716

ETIM 6.0	EC002716
ETIM 7.0	EC002716
ETIM 8.0	EC002716
UNSPSC 16.0901	39121528

Connection diagram

Cd-085

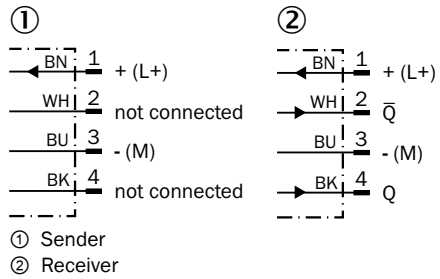

Characteristic curve

WSE2S-2

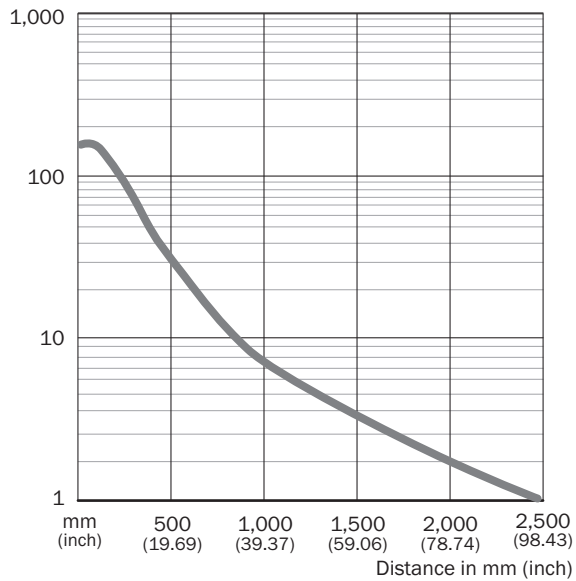

Light spot size

WSE2S-2

Spot diameter in mm (inch)

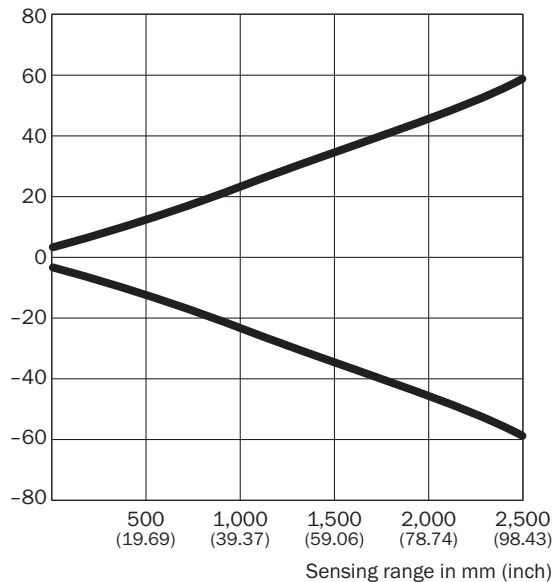

Dimensions in mm (inch)

Sensing range	Spot diameter
10 (0.39)	4.0 (0.16)
250 (9.84)	13.0 (0.51)
500 (19.69)	23.0 (0.91)
1,000 (39.37)	45.0 (1.77)
1,500 (59.06)	65.0 (2.56)
2,500 (98.43)	116.0 (4.57)

Sensing range diagram

WSE2S-2

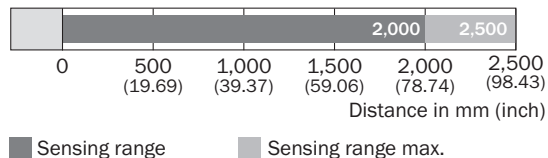

■ Sensing range

■ Sensing range max.

Dimensional drawing (Dimensions in mm (inch))

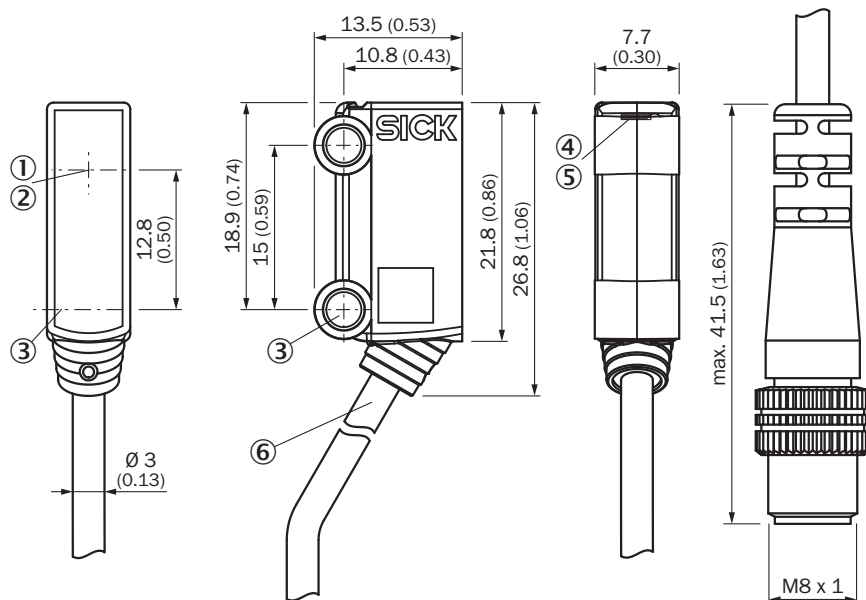

WSE2S-2



- ① Optical axis, receiver
- ② Optical axis, sender
- ③ Middle axis fixing hole \varnothing 3.2 mm
- ④ LED indicator green: power on
- ⑤ LED indicator yellow: Status of received light beam
- ⑥ Connection

Recommended accessories

Other models and accessories → www.sick.com/W2S-2

	Brief description	Type	Part no.
Plug connectors and cables			
	Head A: female connector, M8, 4-pin, straight, A-coded Head B: Flying leads Cable: Sensor/actuator cable, PVC, unshielded, 5 m	YF8U14-050VA3XLEAX	2095889
	Head A: male connector, M8, 4-pin, straight Head B: - Cable: unshielded	STE-0804-G	6037323

SICK AT A GLANCE

SICK is one of the leading manufacturers of intelligent sensors and sensor solutions for industrial applications. A unique range of products and services creates the perfect basis for controlling processes securely and efficiently, protecting individuals from accidents and preventing damage to the environment.

We have extensive experience in a wide range of industries and understand their processes and requirements. With intelligent sensors, we can deliver exactly what our customers need. In application centers in Europe, Asia and North America, system solutions are tested and optimized in accordance with customer specifications. All this makes us a reliable supplier and development partner.

Comprehensive services complete our offering: SICK LifeTime Services provide support throughout the machine life cycle and ensure safety and productivity.

For us, that is “Sensor Intelligence.”

WORLDWIDE PRESENCE:

Contacts and other locations –www.sick.com