

# WL9M4-3P2432

## W9

SMALL PHOTOELECTRIC SENSORS

**SICK**  
Sensor Intelligence.



Illustration may differ



### Ordering information

| Type         | Part no. |
|--------------|----------|
| WL9M4-3P2432 | 1051896  |

Other models and accessories → [www.sick.com/W9](http://www.sick.com/W9)

### Detailed technical data

#### Features

|  |  |
|--|--|
| <b>Device type</b>                     | Photoelectric sensors                                  |
| <b>Sensor/ detection principle</b>     | Photoelectric retro-reflective sensor, autocollimation |
| <b>Dimensions (W x H x D)</b>          | 12.2 mm x 52.2 mm x 23.6 mm                            |
| <b>Housing design (light emission)</b> | Rectangular  |
| <b>Mounting hole</b>                   | M4   |
| <b>Sensing range max.</b>              | 0 m ... 5 m <sup>1)</sup>                              |
| <b>Sensing range</b>                   | 0 m ... 3 m <sup>1)</sup>                              |
| <b>Type of light</b>                   | Visible red light                                      |
| <b>Light source</b>                    | PinPoint LED <sup>2)</sup>                             |
| <b>Light spot size (distance)</b>      | Ø 45 mm (1.5 m)  |
| <b>Wave length</b>                     | 650 nm   |
| <b>Adjustment</b>                      | Single teach-in button                                 |
| <b>Special applications</b>            | Detecting small objects                                |

<sup>1)</sup> Reflector PL80A.

<sup>2)</sup> Average service life: 100,000 h at T<sub>J</sub> = +25 °C.

## Mechanics/electronics

|  |  |
|--|--|
| <b>Supply voltage</b>                  | 10 V DC ... 30 V DC <sup>1)</sup>                      |
| <b>Ripple</b>                          | < 5 V <sub>pp</sub> <sup>2)</sup>                      |
| <b>Current consumption</b>             | 30 mA <sup>3)</sup>                                    |
| <b>Switching output</b>                | PNP <sup>4)</sup>                                      |
| <b>Output function</b>                 | Complementary  |
| <b>Switching mode</b>                  | Light/dark switching <sup>4)</sup>                     |
| <b>Output current I<sub>max.</sub></b> | ≤ 100 mA <sup>5)</sup>                                 |
| <b>Response time</b>                   | < 0.5 ms <sup>6)</sup>                                 |
| <b>Switching frequency</b>             | 1,000 Hz <sup>7)</sup>                                 |
| <b>Connection type</b>                 | Male connector M12, 4-pin                              |
| <b>Circuit protection</b>              | A <sup>8)</sup><br>B <sup>9)</sup><br>C <sup>10)</sup> |
| <b>Protection class</b>                | III  |
| <b>Weight</b>                          | 13 g   |
| <b>Polarisation filter</b>             | ✓  |
| <b>Housing material</b>                | Plastic, VISTAL®                                       |
| <b>Optics material</b>                 | Plastic, PMMA  |
| <b>Enclosure rating</b>                | IP66<br>IP67<br>IP69K                                  |
| <b>Ambient operating temperature</b>   | -40 °C ... +60 °C                                      |
| <b>Ambient temperature, storage</b>    | -40 °C ... +75 °C                                      |
| <b>UL File No.</b>                     | NRKH.E181493   |

<sup>1)</sup> Limit values when operated in short-circuit protected network: max. 8 A.

<sup>2)</sup> May not exceed or fall below U<sub>v</sub> tolerances.

<sup>3)</sup> Without load.

<sup>4)</sup> Q = light switching.

<sup>5)</sup> At and above T<sub>u</sub> 50 °C, a max. load current of I<sub>max.</sub> = 50 mA is permitted.

<sup>6)</sup> Signal transit time with resistive load.

<sup>7)</sup> With light/dark ratio 1:1.

<sup>8)</sup> A = V<sub>S</sub> connections reverse-polarity protected.

<sup>9)</sup> B = inputs and output reverse-polarity protected.

<sup>10)</sup> C = interference suppression.

## Classifications

|                     |          |
|---------------------|----------|
| <b>ECl@ss 5.0</b>   | 27270902 |
| <b>ECl@ss 5.1.4</b> | 27270902 |
| <b>ECl@ss 6.0</b>   | 27270902 |
| <b>ECl@ss 6.2</b>   | 27270902 |
| <b>ECl@ss 7.0</b>   | 27270902 |
| <b>ECl@ss 8.0</b>   | 27270902 |
| <b>ECl@ss 8.1</b>   | 27270902 |
| <b>ECl@ss 9.0</b>   | 27270902 |

|                       |          |
|-----------------------|----------|
| <b>ECl@ss 10.0</b>    | 27270902 |
| <b>ECl@ss 11.0</b>    | 27270902 |
| <b>ETIM 5.0</b>       | EC002717 |
| <b>ETIM 6.0</b>       | EC002717 |
| <b>ETIM 7.0</b>       | EC002717 |
| <b>ETIM 8.0</b>       | EC002717 |
| <b>UNSPSC 16.0901</b> | 39121528 |

### Connection type

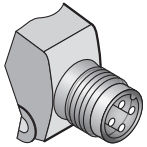

### Connection diagram

Cd-084

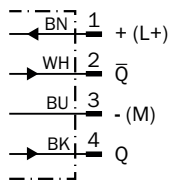

### Characteristic curve

WL9-3, red light, 5 m

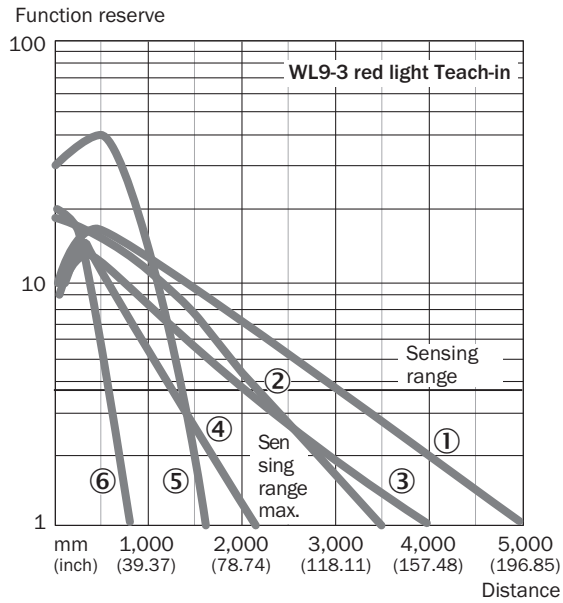

- ① Reflector PL80A
- ② Reflector P250
- ③ Reflector PL40A
- ④ Reflector PL20A
- ⑤ PL10F reflector
- ⑥ Reflective tape REF-IRF-56

### Light spot size

WL9-3, red light, 5 m

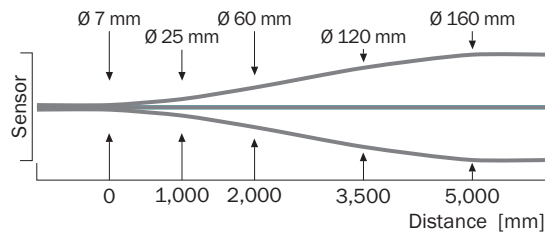

### Sensing range diagram

WL9-3, red light, 5 m



- ① Reflector PL80A
- ② Reflector P250F
- ③ Reflector PL40A
- ④ Reflector PL20F
- ⑤ PL10F reflector
- ⑥ Reflective tape REF-IRF-56

### Adjustments

Single teach-in button

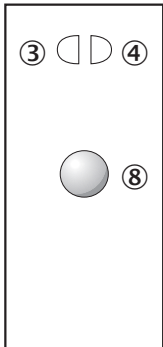

- ③ LED indicator yellow: Status of received light beam
- ④ LED indicator green: power on
- ⑧ Teach-in button

**Dimensional drawing** (Dimensions in mm (inch))



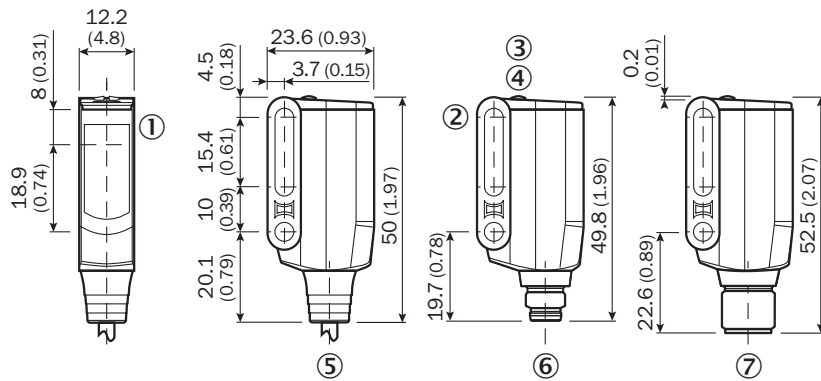

WL9M4-3, WSE9M4-3



- ① Sender and receiver optical axis center
- ② Mounting hole M4 (Ø 4.1 mm)
- ③ LED indicator yellow: Status of received light beam
- ④ LED indicator green: power on
- ⑤ Connecting cable or connector
- ⑥ Male connector M8, 4-pin
- ⑦ Male connector M12, 4-pin

**Recommended accessories**

Other models and accessories → [www.sick.com/W9](http://www.sick.com/W9)

|   | Brief description   | Type               | Part no. |
|---|---|--------------------|----------|
| <b>Plug connectors and cables</b>   |   |                    |          |
|  | Head A: female connector, M12, 4-pin, straight, A-coded<br>Head B: Flying leads<br>Cable: Sensor/actuator cable, PVC, unshielded, 5 m | YF2A14-050VB3XLEAX | 2096235  |
|  | Head A: female connector, M8, 4-pin, straight, A-coded<br>Head B: Flying leads<br>Cable: Sensor/actuator cable, PVC, unshielded, 5 m  | YF8U14-050VA3XLEAX | 2095889  |
|  | Head A: male connector, M8, 4-pin, straight<br>Head B: -<br>Cable: unshielded   | STE-0804-G         | 6037323  |
|  | Head A: male connector, M12, 4-pin, straight<br>Head B: -<br>Cable: unshielded  | STE-1204-G         | 6009932  |
| <b>Reflectors</b>   |   |                    |          |
|  | Fine triple reflector, screw connection, suitable for laser sensors, 20 mm x 32 mm, PM-MA/ABS, Screw-on, 2 hole mounting              | PL10F              | 5311210  |

## SICK AT A GLANCE

SICK is one of the leading manufacturers of intelligent sensors and sensor solutions for industrial applications. A unique range of products and services creates the perfect basis for controlling processes securely and efficiently, protecting individuals from accidents and preventing damage to the environment.

We have extensive experience in a wide range of industries and understand their processes and requirements. With intelligent sensors, we can deliver exactly what our customers need. In application centers in Europe, Asia and North America, system solutions are tested and optimized in accordance with customer specifications. All this makes us a reliable supplier and development partner.

Comprehensive services complete our offering: SICK LifeTime Services provide support throughout the machine life cycle and ensure safety and productivity.

For us, that is “Sensor Intelligence.”

## WORLDWIDE PRESENCE:

Contacts and other locations –[www.sick.com](http://www.sick.com)