



WTT12L-A2513

PowerProx

MULTITASK PHOTOELECTRIC SENSORS

SICK
Sensor Intelligence.

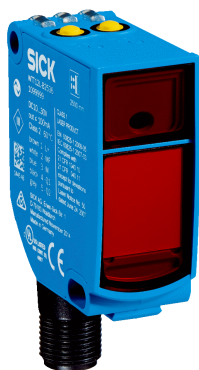

Illustration may differ



Ordering information

Type	Part no.
WTT12L-A2513	1082476

Other models and accessories → www.sick.com/PowerProx

Detailed technical data

Features

Device type	Photoelectric sensors
Sensor/ detection principle	Photoelectric proximity sensor, Background suppression
Dimensions (W x H x D)	20 mm x 49.6 mm x 44.2 mm
Housing design (light emission)	Rectangular
Sensing range max.	50 mm ... 1,600 mm ¹⁾
Sensing range	100 mm ... 1,600 mm ²⁾
Distance value	
Measuring range	100 mm ... 1,600 mm ¹⁾
Resolution	1 mm
Repeatability	2,7 mm ... 8,0 mm ^{3) 4) 5)}
Accuracy	Typ. ± 20 mm ⁶⁾ Typ. ± 15 mm ⁷⁾
Type of light	Visible red light
Light source	Laser ⁸⁾
Light spot size (distance)	Ø 11 mm (1,600 mm)
Wave length	658 nm
Laser class	1 (IEC 60825-1 / CDRH 21 CFR 1040.10 & 1040.11)

¹⁾ Object with 6 ... 90 % remission (based on standard white to DIN 5033).

²⁾ Adjustable.

³⁾ Equivalent to 1 σ .

⁴⁾ See characteristic curves repeatability.

⁵⁾ 6 % ... 90 % remission.

⁶⁾ 50 ... 1000 mm.

⁷⁾ 1000 ... 1600 mm.

⁸⁾ Average service life: 100,000 h at T_J = +25 °C.

Adjustment	Single teach-in button (2 x)
-------------------	------------------------------

- 1) Object with 6 ... 90 % remission (based on standard white to DIN 5033).
- 2) Adjustable.
- 3) Equivalent to 1 σ .
- 4) See characteristic curves repeatability.
- 5) 6 % ... 90 % remission.
- 6) 50 ... 1000 mm.
- 7) 1000 ... 1600 mm.
- 8) Average service life: 100,000 h at $T_U = +25 \text{ }^\circ\text{C}$.

Mechanics/electronics

Supply voltage	12 V DC ... 30 V DC ^{1) 2)}
Ripple	< 5 V _{pp} ³⁾
Current consumption	70 mA ⁴⁾
Switching output	Push-pull: PNP/NPN ⁵⁾
Number of switching outputs	1 (Q ₁) ⁵⁾
Switching mode	Light switching ⁵⁾
Output current I_{max}	≤ 50 mA
Response time	≤ 0.5 ms ⁶⁾
Switching frequency	1,000 Hz ⁷⁾
Analog output	4 mA ... 20 mA (≤ 450 Ω) / 0 V ... 10 V (≥ 50 kΩ) / switchable
Resolution of analog output	12 bit
Output time	≤ 3 ms
Input	Sender off
Connection type	Male connector M12, 5-pin
Circuit protection	A ⁸⁾ B ⁹⁾ C ¹⁰⁾
Protection class	III
Weight	48 g
Housing material	Plastic, VISTAL®
Optics material	Plastic, PMMA
Enclosure rating	IP67
Ambient operating temperature	-35 °C ... +50 °C ¹¹⁾

- 1) Limit values. Operated in short-circuit protected network: max. 8 A.
- 2) V_s min when using the voltage output = 13 V.
- 3) May not exceed or fall below U_v tolerances.
- 4) Without load. At V_S = 24 V.
- 5) Q₁ = 1 switching threshold, light switching.
- 6) Signal transit time with resistive load.
- 7) With light/dark ratio 1:1.
- 8) A = V_S connections reverse-polarity protected.
- 9) B = inputs and output reverse-polarity protected.
- 10) C = interference suppression.
- 11) For V_s ≤ 24 V. When T_u = 45 °C or above, a maximum load resistance of 300 Ω ... 450 Ω is permitted on QA.
- 12) Below T_u = -10 °C a warm-up time is necessary.

Ambient temperature, storage	-40 °C ... +70 °C
Warm-up time	< 15 min ¹²⁾
Initialization time	< 300 ms
UL File No.	NRKH.E181493

- 1) Limit values. Operated in short-circuit protected network: max. 8 A.
 2) V_S min when using the voltage output = 13 V.
 3) May not exceed or fall below U_V tolerances.
 4) Without load. At $V_S = 24$ V.
 5) $Q1 = 1$ switching threshold, light switching.
 6) Signal transit time with resistive load.
 7) With light/dark ratio 1:1.
 8) A = V_S connections reverse-polarity protected.
 9) B = inputs and output reverse-polarity protected.
 10) C = interference suppression.
 11) For $V_S \leq 24$ V. When $T_U = 45$ °C or above, a maximum load resistance of 300 Ω ... 450 Ω is permitted on QA.
 12) Below $T_U = -10$ °C a warm-up time is necessary.

Safety-related parameters

MTTF_D	124 years
DC_{avg}	0 %
T_M (mission time)	20 years

Classifications

ECl@ss 5.0	27270904
ECl@ss 5.1.4	27270904
ECl@ss 6.0	27270904
ECl@ss 6.2	27270904
ECl@ss 7.0	27270904
ECl@ss 8.0	27270904
ECl@ss 8.1	27270904
ECl@ss 9.0	27270904
ECl@ss 10.0	27270904
ECl@ss 11.0	27270904
ETIM 5.0	EC002719
ETIM 6.0	EC002719
ETIM 7.0	EC002719
ETIM 8.0	EC002719
UNSPSC 16.0901	39121528

Connection/pin assignment

Connection type	Male connector M12, 5-pin
------------------------	---------------------------

Connection diagram

Cd-375

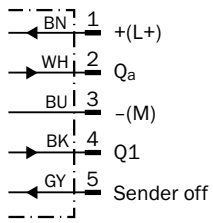

Characteristic curve

Min. distance from object to background in mm (inch)

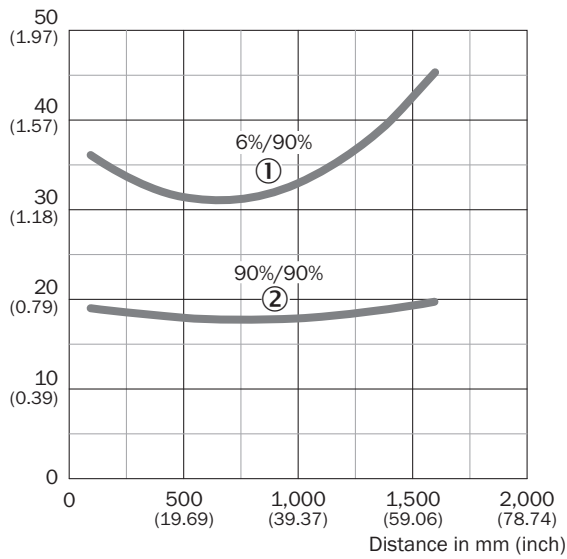

- ① Sensing range on black, 6% remission
- ② Sensing range on white, 90% remission

Light spot size

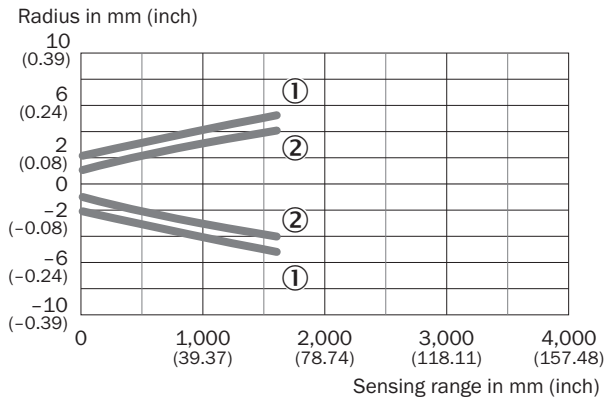

- ① Light spot horizontal
- ② Light spot vertical

Repeatability

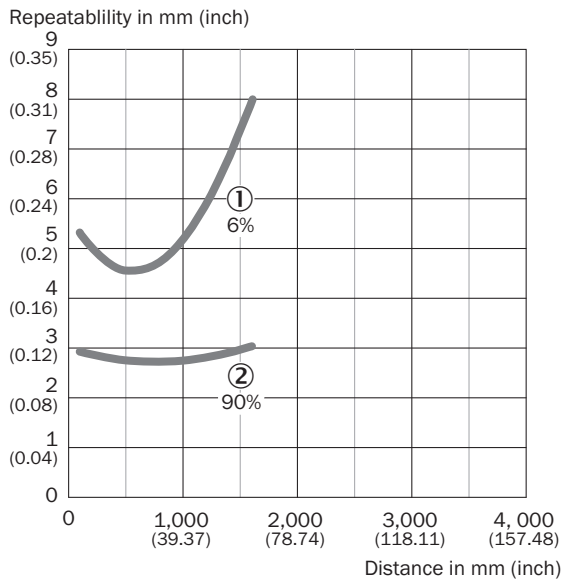

- ① 6 % remission, on black
- ② 90 % remission, on white

Dimensional drawing (Dimensions in mm (inch))

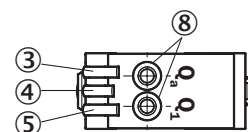
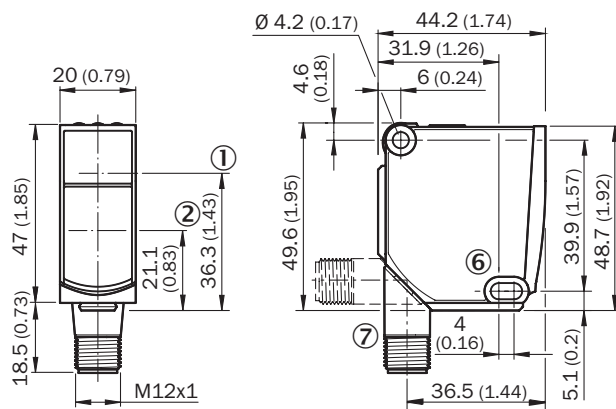

- ① Optical axis, sender
- ② Optical axis, receiver
- ③ LED indicator yellow: Status of analog output
- ④ LED indicator green: power on
- ⑤ Status indicator LED, yellow: Status switching output
- ⑥ Mounting hole, \varnothing 4.2 mm
- ⑦ Connection
- ⑧ Single teach-in button

Recommended accessories

Other models and accessories → www.sick.com/PowerProx

	Brief description	Type	Part no.
Mounting brackets and plates			
	BEF-WTT12L	BEF-WTT12L	2078538
Plug connectors and cables			
	Head A: female connector, M12, 5-pin, straight, A-coded Head B: Flying leads Cable: Sensor/actuator cable, PVC, unshielded, 5 m	YF2A15-050VB5XLEAX	2096240
	Head A: male connector, M12, 5-pin, straight Cable: unshielded For field bus technology	STE-1205-G	6022083

SICK AT A GLANCE

SICK is one of the leading manufacturers of intelligent sensors and sensor solutions for industrial applications. A unique range of products and services creates the perfect basis for controlling processes securely and efficiently, protecting individuals from accidents and preventing damage to the environment.

We have extensive experience in a wide range of industries and understand their processes and requirements. With intelligent sensors, we can deliver exactly what our customers need. In application centers in Europe, Asia and North America, system solutions are tested and optimized in accordance with customer specifications. All this makes us a reliable supplier and development partner.

Comprehensive services complete our offering: SICK LifeTime Services provide support throughout the machine life cycle and ensure safety and productivity.

For us, that is “Sensor Intelligence.”

WORLDWIDE PRESENCE:

Contacts and other locations –www.sick.com