



WSU26/3-103A00S01

WSU/WEU26-3

SAFETY SINGLE-BEAM SENSORS

SICK
Sensor Intelligence.



Ordering information

Scanning range	System part	Type	Part no.
70 m	Sender	WSU26/3-103A00S01	1089126

Other models and accessories → www.sick.com/WSU_WEU26-3



Detailed technical data

Features

Type of light	Infrared light
Scanning range	70 m
Dimension of the light path	15 m ... 70 m
Number of beams	1
Detection capability	30 mm
Front screen heating	✓
Synchronization	Optical synchronisation

Safety-related parameters

Type	Type 4 (IEC 61496-1)
Safety integrity level	SIL3 (IEC 61508)
Category	Category 4 (EN ISO 13849)
Performance level	PL e (EN ISO 13849)
B_{10d} parameter	1 x 10 ⁶ switching cycles (DC-13, 24 V, 0.6 A), 2 x 10 ⁵ switching cycles (DC-13, 24 V, 1.5 A)
PFH_D (mean probability of a dangerous failure per hour)	4.0 x 10 ⁻⁹ (EN ISO 13849)
T_M (mission time)	20 years (EN ISO 13849)
Safe state in the event of a fault	At least one OSSD is in the OFF state.

Interfaces

Connection type	Male connector M12, 8-pin
Display elements	LEDs

Electrical data

Protection class	I (EN 50178)
Supply voltage V_S	24 V DC (19.2 V DC ... 28.8 V DC)
Power consumption	≤ 6 W

¹⁾ Upon applying the supply voltage.

Switch-on time	≤ 10 s ¹⁾
Test input	Volt-free N/C contact

¹⁾ Upon applying the supply voltage.

Mechanical data

Design	Rectangular
Dimensions (W x H x D)	50 mm x 156 mm x 116 mm
Housing material	Aluminum die cast
Front screen material	Polycarbonate, scratch-resistant coating
Weight	≤ 1 kg

Ambient data

Enclosure rating	IP67 (EN 60529)
Ambient operating temperature	-25 °C ... +55 °C
Storage temperature	-25 °C ... +70 °C
Air humidity	15 % ... 95 %, Non-condensing
Vibration resistance	5 g, 10 Hz ... 55 Hz (IEC 60068-2-6)
Shock resistance	10 g, 16 ms (IEC 60068-2-29)

Other information

Type of light	Infrared light
Wave length	950 nm

Classifications





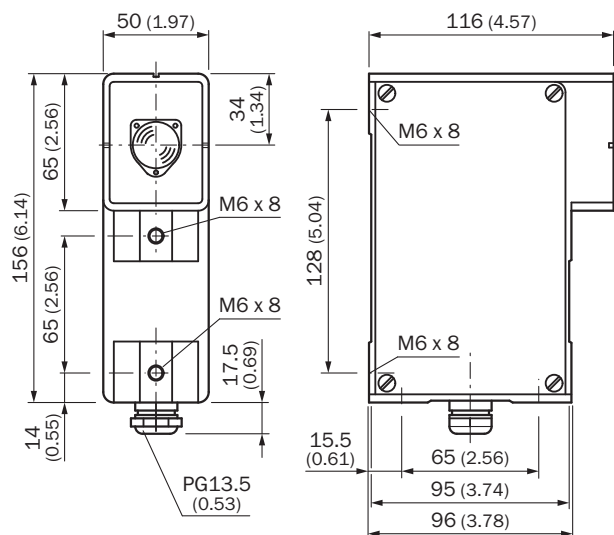

eCl@ss 5.0	27272701
eCl@ss 5.1.4	27272701
eCl@ss 6.0	27272701
eCl@ss 6.2	27272701
eCl@ss 7.0	27272701
eCl@ss 8.0	27272701
eCl@ss 8.1	27272701
eCl@ss 9.0	27272701
eCl@ss 10.0	27272701
eCl@ss 11.0	27272701
eCl@ss 12.0	27272701
ETIM 5.0	EC001831
ETIM 6.0	EC001831
ETIM 7.0	EC001831
ETIM 8.0	EC001831
UNSPSC 16.0901	46171620

Dimensional drawing (Dimensions in mm (inch))

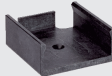

Recommended accessories

Other models and accessories → www.sick.com/WSU_WEU26-3

	Brief description	Type	Part no.
Alignment aids			
	Laser alignment aid for various sensors, laser class 2 (IEC 60825). Do not look into the beam!, 19 mm x 67.3 mm x 66.9 mm	AR60	1015741
	Adapter AR60 for WSU/WEU26-3 and WSU/WEU26/2	AR60 adapter, WSU/WEU26	4031156
Deflector mirrors			
	Horizontal deflection, 75 mm x 80 mm reflector surface, Glass, Incl. mounting kit (2 x swivel mount)	PNS75-008	1026647
	Horizontal deflection, 96 mm x 124 mm reflector surface, Glass	PSK1	1005229
	Deflector mirror for 90° deflection, mirror surface 97 mm x 80 mm, not suitable for column mounting, Glass, mounting hardware included	PSK45	5306053
Test and monitoring tools			
	30 mm diameter, 250 mm length	Test rod 30 mm	2022602
Mounting brackets and plates			
	Bracket, face side mounting position	BEF-4WNAEFAL1	2007900

	Brief description	Type	Part no.	
	Spring mounting for PSK1 deflector mirror	BEF-4AAAAHST3	2012473	
Plug connectors and cables				
	Head A: female connector, M12, 8-pin, straight, A-coded Head B: Flying leads Cable: Sensor/actuator cable, PUR, halogen-free, unshielded, 2.5 m	YF2A18-025UA5XLEAX	2099229	
	Head A: female connector, M12, 8-pin, straight, A-coded Head B: Flying leads Cable: Sensor/actuator cable, PUR, halogen-free, unshielded, 5 m	YF2A18-050UA5XLEAX	2095653	
	Head A: female connector, M12, 8-pin, straight, A-coded Head B: Flying leads Cable: Sensor/actuator cable, PUR, halogen-free, unshielded, 7.5 m	YF2A18-075UA5XLEAX	2099230	
	Head A: female connector, M12, 8-pin, straight, A-coded Head B: Flying leads Cable: Sensor/actuator cable, PUR, halogen-free, unshielded, 10 m	YF2A18-100UA5XLEAX	2095654	
		Head A: female connector, M12, 8-pin, angled, A-coded Head B: Flying leads Cable: Sensor/actuator cable, PUR, halogen-free, unshielded, 2 m	YG2A18-020UA5XLEAX	2095779
		Head A: female connector, M12, 8-pin, angled, A-coded Head B: Flying leads Cable: Sensor/actuator cable, PUR, halogen-free, unshielded, 5 m	YG2A18-050UA5XLEAX	2095780
		Head A: female connector, M12, 8-pin, angled, A-coded Head B: Flying leads Cable: Sensor/actuator cable, PUR, halogen-free, unshielded, 10 m	YG2A18-100UA5XLEAX	2095781

SICK AT A GLANCE

SICK is one of the leading manufacturers of intelligent sensors and sensor solutions for industrial applications. A unique range of products and services creates the perfect basis for controlling processes securely and efficiently, protecting individuals from accidents and preventing damage to the environment.

We have extensive experience in a wide range of industries and understand their processes and requirements. With intelligent sensors, we can deliver exactly what our customers need. In application centers in Europe, Asia and North America, system solutions are tested and optimized in accordance with customer specifications. All this makes us a reliable supplier and development partner.

Comprehensive services complete our offering: SICK LifeTime Services provide support throughout the machine life cycle and ensure safety and productivity.

For us, that is “Sensor Intelligence.”

WORLDWIDE PRESENCE:

Contacts and other locations –www.sick.com