



IMG12-04BNSZU2K

IMG

INDUCTIVE PROXIMITY SENSORS

SICK
Sensor Intelligence.

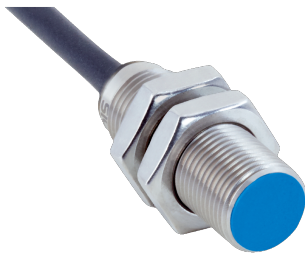

Illustration may differ



Ordering information

Type	Part no.
IMG12-04BNSZU2K	1135520

Included in delivery: BEF-MU-M12 (1)

Other models and accessories → www.sick.com/IMG

Detailed technical data

Features

Housing	Metric
Housing	Short-body
Thread size	M12 x 1
Diameter	Ø 12 mm
Sensing range S_n	4 mm
Safe sensing range S_a	3.24 mm
Installation type	Flush
Switching frequency	2,000 Hz
Connection type	Cable, 3-wire, 2 m
Switching output	NPN
Switching output detail	NPN
Output function	NO
Electrical wiring	DC 3-wire
Enclosure rating	IP67 ¹⁾ IP68 ¹⁾ IP69K ²⁾
Special features	Resistant against coolant lubricants, Temperature resistance
Special applications	Zones with coolants and lubricants, Mobile machines, Difficult application conditions
Items supplied	Mounting nut, brass, nickel-plated (2x)

¹⁾ According to EN 60529.

²⁾ According to ISO 20653:2013-03.

Mechanics/electronics

Supply voltage	10 V DC ... 30 V DC
Ripple	≤ 10 %

¹⁾ At I_a max.

²⁾ Supply voltage U_B and constant ambient temperature T_a .

³⁾ Of S_r .

Voltage drop	$\leq 2 \text{ V}^{1)}$
Time delay before availability	$\leq 100 \text{ ms}$
Hysteresis	3 % ... 20 %
Reproducibility	$\leq 2 \text{ \%}^{2) 3)}$
Temperature drift (of S_r)	$\pm 10 \text{ \%}$
EMC	According to EN 60947-5-2
Environmental test	Quick temperature change EN 60068-2-14, Na: TA = -25 °C, TB = 75 °C, t1 = 40 min, t2 = < 10 s, 300 cycles
Corrosion test	Salt spray test EN 60068-2-52: severity 5, 4 cycles
Continuous current I_a	$\leq 200 \text{ mA}$
No load current	$\leq 10 \text{ mA}$
Cable material	PUR
Conductor size	0.25 mm ²
Cable diameter	Ø 3.9 mm
Bending radius	With fixed installation > 5 x cable diameter For flexible use > 10 x cable diameter
Short-circuit protection	✓
Power-up pulse protection	✓
Shock and vibration resistance	Vibration resistance acc. to EN 60068-2-6 Fc: 60 g peak (10 Hz ... 2,000 Hz) Long-term shock resistance acc. to EN 60068-2-27 Ea: 100 g 2 ms sinusoidal; 500 shocks in each direction of the 3 coordinate axes Broadband noise acc. to EN 60068-2-64: 15 g rms (5 Hz ... 2,000 Hz) / 8 hours in each direction of the 3 coordinate axes
Indication	LED yellow Switching status Permanently on: Switching output active
Ambient operating temperature	-40 °C ... +85 °C
Housing material	Nickel-plated brass
Sensing face material	Plastic, LCP
Housing length	35 mm
Thread length	31 mm
Tightening torque, max.	$\leq 12 \text{ Nm}$
Protection class	III
UL File No.	E181493

1) At I_a max.

2) Supply voltage U_B and constant ambient temperature T_a .

3) Of S_r .

Safety-related parameters

MTTF_D	1,820 years
DC_{avg}	0 %
T_M (mission time)	20 years

Reduction factors

Note	The values are reference values which may vary
-------------	--

St37 steel (Fe)	1
Stainless steel (V2A, 304)	Approx. 0.78
Aluminum (Al)	Approx. 0.49
Copper (Cu)	Approx. 0.37
Brass (Br)	Approx. 0.53

Installation note

Remark	Associated graphic see "Installation"
B	12 mm
C	12 mm
D	12 mm
F	32 mm

Classifications

ECLASS 5.0	27270101
ECLASS 5.1.4	27270101
ECLASS 6.0	27270101
ECLASS 6.2	27270101
ECLASS 7.0	27270101
ECLASS 8.0	27270101
ECLASS 8.1	27270101
ECLASS 9.0	27270101
ECLASS 10.0	27270101
ECLASS 11.0	27270101
ECLASS 12.0	27274001
ETIM 5.0	EC002714
ETIM 6.0	EC002714
ETIM 7.0	EC002714
ETIM 8.0	EC002714
UNSPSC 16.0901	39122230

Installation note

Flush installation

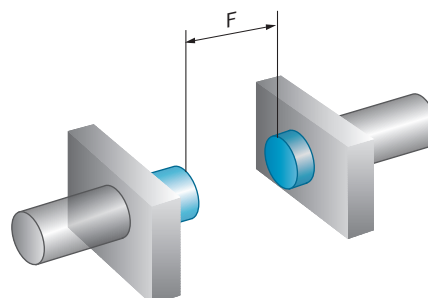
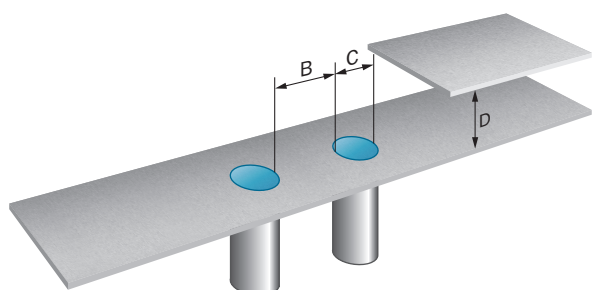

Connection diagram

Cd-001

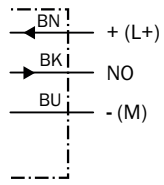

Response diagram

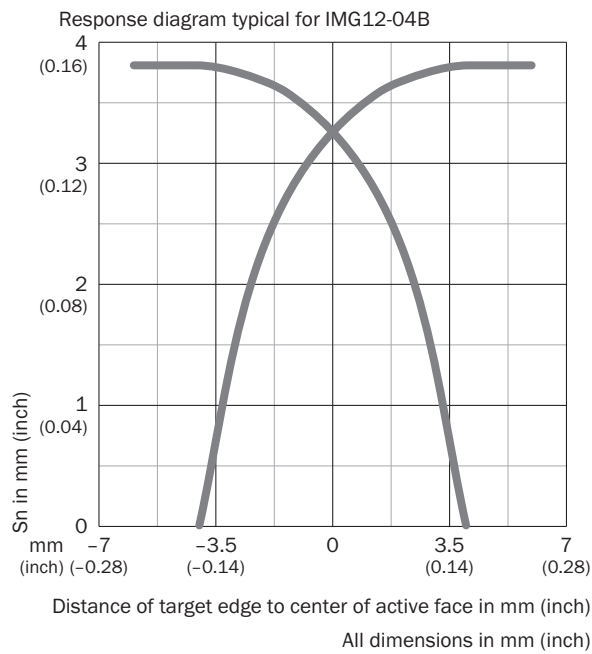

Functional principle

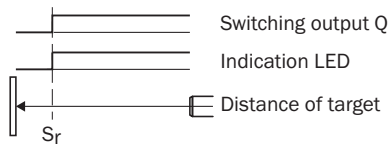

Dimensional drawing (Dimensions in mm (inch))



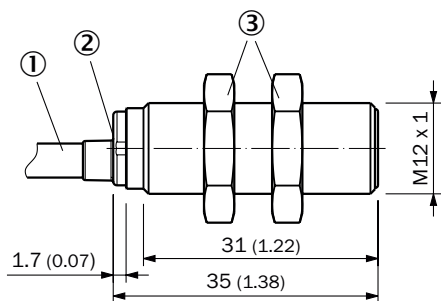



IMG12, short variant, cable, flush



- ① Connection
- ② Display LED
- ③ Fastening nuts (2x); AF17; nickel-plated brass

Recommended accessories

Other models and accessories → www.sick.com/IMG

	Brief description	Type	Part no.
Mounting brackets and plates			
	<ul style="list-style-type: none"> Description: Mounting plate for M12 sensors Material: Steel Details: Steel, zinc coated Items supplied: Without mounting hardware 	BEF-WG-M12	5321869
	<ul style="list-style-type: none"> Description: Mounting bracket for M12 sensors Material: Steel Details: Steel, zinc coated Items supplied: Without mounting hardware 	BEF-WN-M12	5308447
Others			
	<ul style="list-style-type: none"> Connection type head A: Female connector, M12, 4-pin, straight, A-coded Description: Unshielded Connection systems: Screw-type terminals Permitted cross-section: ≤ 0.75 mm² Application: Hygienic and washdown zones 	DOS-1204-GN	6028357
	<ul style="list-style-type: none"> Connection type head A: Male connector, M12, 4-pin, straight, A-coded Description: Unshielded Connection systems: Screw-type terminals Permitted cross-section: ≤ 0.75 mm² Application: Hygienic and washdown zones 	STE-1204-GN	6028359
	<ul style="list-style-type: none"> Connection type head A: Female connector, M12, 4-pin, angled, A-coded Description: Unshielded Connection systems: Screw-type terminals Permitted cross-section: ≤ 0.75 mm² Application: Hygienic and washdown zones 	DOS-1204-WN	6028358
	<ul style="list-style-type: none"> Connection type head A: Male connector, M12, 4-pin, straight, A-coded Description: Unshielded Connection systems: Screw-type terminals Permitted cross-section: ≤ 0.75 mm² Note: For 2 cable connections Application: Hygienic and washdown zones 	STE-1204-TN	6028360

SICK AT A GLANCE

SICK is one of the leading manufacturers of intelligent sensors and sensor solutions for industrial applications. A unique range of products and services creates the perfect basis for controlling processes securely and efficiently, protecting individuals from accidents and preventing damage to the environment.

We have extensive experience in a wide range of industries and understand their processes and requirements. With intelligent sensors, we can deliver exactly what our customers need. In application centers in Europe, Asia and North America, system solutions are tested and optimized in accordance with customer specifications. All this makes us a reliable supplier and development partner.

Comprehensive services complete our offering: SICK LifeTime Services provide support throughout the machine life cycle and ensure safety and productivity.

For us, that is “Sensor Intelligence.”

WORLDWIDE PRESENCE:

Contacts and other locations –www.sick.com