



WT130L-32

W130 Laser

MINIATURE PHOTOELECTRIC SENSORS

SICK
Sensor Intelligence.



Illustration may differ



Ordering information

Type	Part no.
WT130L-32	6029861

Other models and accessories → www.sick.com/W130_Laser

Detailed technical data

Features

Device type	Photoelectric sensors
Sensor/ detection principle	Photoelectric proximity sensor, Energetic
Dimensions (W x H x D)	13.4 mm x 26.5 mm x 34.6 mm
Housing design (light emission)	Rectangular
Sensing range max.	0 mm ... 1,200 mm
Sensing range	30 mm ... 1,000 mm ¹⁾
Type of light	Visible red light
Light source	Laser ²⁾
Light spot size (distance)	Ø 1 mm (1 m)
Laser class	2, IEC 60 825-1/C.D.R.H.
Adjustment	None

¹⁾ Object with 90% remission (based on standard white DIN 5033). Sensing range depends on operating mode selected.

²⁾ Average service life: 50,000 h at T_U = +25 °C.

Mechanics/electronics

Connection type	Cable with male connector, 2 m ^{1) 2)}
Cable material	PVC/PBT
Protection class	III
Weight	35 g
Housing material	Plastic, PC
Optics material	Glass, glass
Enclosure rating	IP67
Ambient operating temperature	-10 °C ... +55 °C
Ambient temperature, storage	-25 °C ... +70 °C

¹⁾ Connection between sensor head and evaluation unit with system-specific connector.

²⁾ Do not bend below 0 °C.

UL File No.	242361 (0720256-00)
--------------------	---------------------

- 1) Connection between sensor head and evaluation unit with system-specific connector.
- 2) Do not bend below 0 °C.

Classifications

ECl@ss 5.0	27270903
ECl@ss 5.1.4	27270903
ECl@ss 6.0	27270903
ECl@ss 6.2	27270903
ECl@ss 7.0	27270903
ECl@ss 8.0	27270903
ECl@ss 8.1	27270903
ECl@ss 9.0	27270903
ECl@ss 10.0	27270904
ECl@ss 11.0	27270904
ECl@ss 12.0	27270903
ETIM 5.0	EC001821
ETIM 6.0	EC001821
ETIM 7.0	EC002719
ETIM 8.0	EC002719
UNSPSC 16.0901	39121528

Connection type

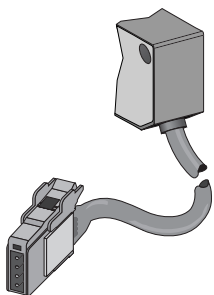

Characteristic curve

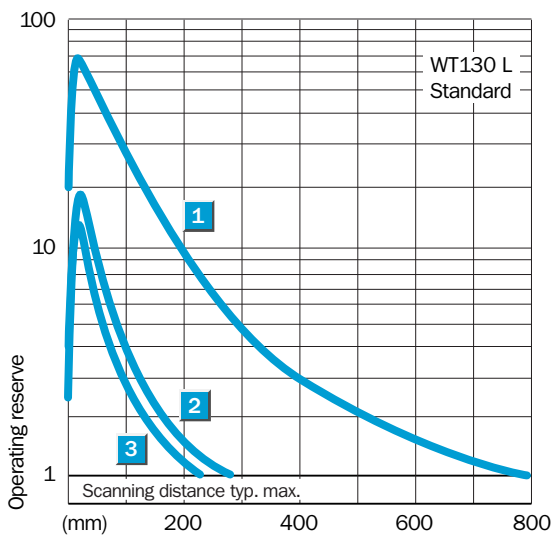
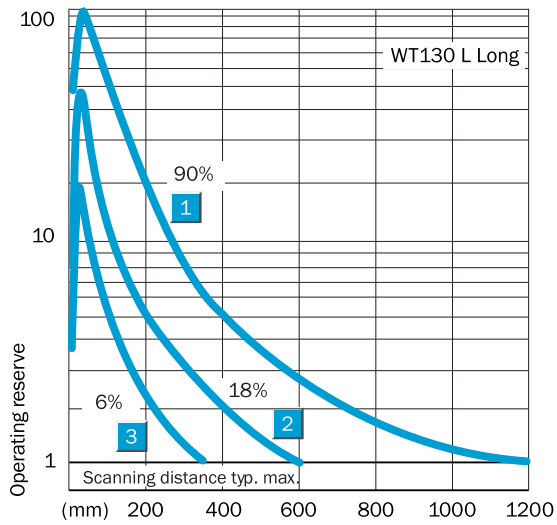
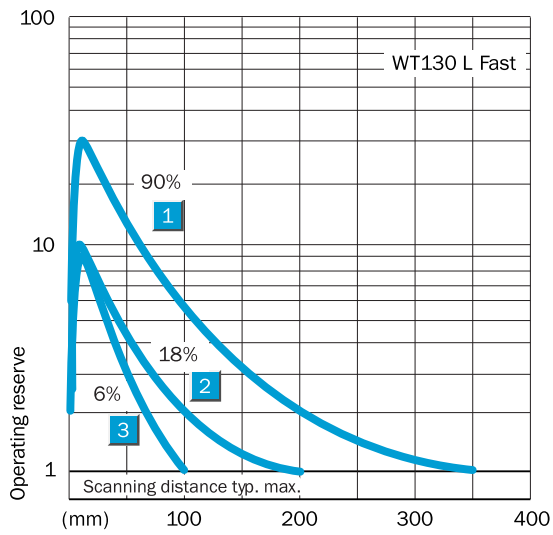

Light spot size

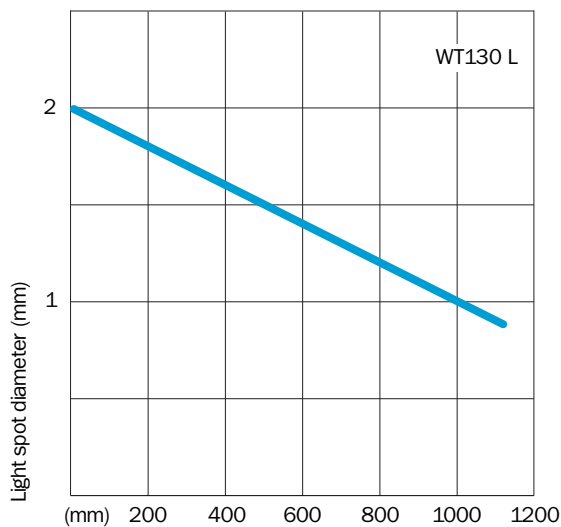

Sensing range diagram

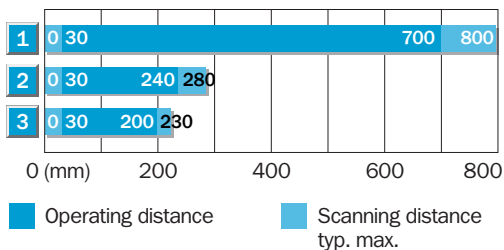

- 1 Scanning distance on white, 90 % remission
- 2 Scanning distance on grey, 18 % remission
- 3 Scanning distance on black, 6 % remission

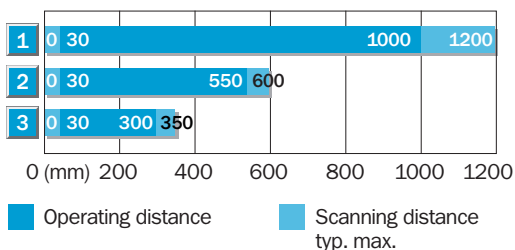

- 1 Scanning distance on white, 90 % remission
- 2 Scanning distance on grey, 18 % remission
- 3 Scanning distance on black, 6 % remission

WT130L-32 | W130 Laser

MINIATURE PHOTOELECTRIC SENSORS

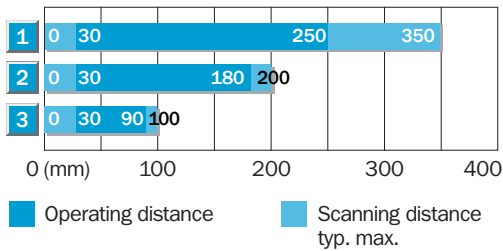

1	Scanning distance on white, 90 % remission
2	Scanning distance on grey, 18 % remission
3	Scanning distance on black, 6 % remission

Dimensional drawing (Dimensions in mm (inch))

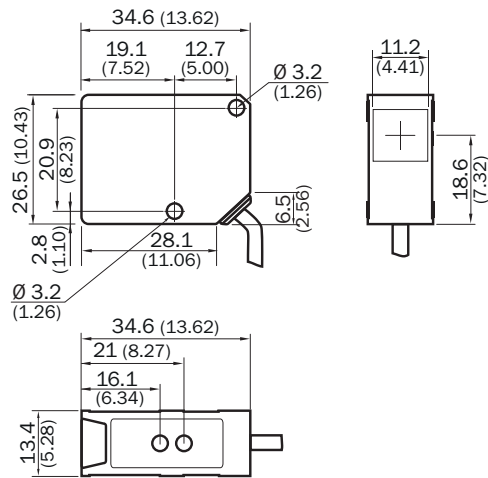

- ① Mounting hole $\varnothing 3.2$ mm
- ② Optical axis
- ③ LED indicator green: Supply voltage active
- ④ LED indicator orange: switching output active

SICK AT A GLANCE

SICK is one of the leading manufacturers of intelligent sensors and sensor solutions for industrial applications. A unique range of products and services creates the perfect basis for controlling processes securely and efficiently, protecting individuals from accidents and preventing damage to the environment.

We have extensive experience in a wide range of industries and understand their processes and requirements. With intelligent sensors, we can deliver exactly what our customers need. In application centers in Europe, Asia and North America, system solutions are tested and optimized in accordance with customer specifications. All this makes us a reliable supplier and development partner.

Comprehensive services complete our offering: SICK LifeTime Services provide support throughout the machine life cycle and ensure safety and productivity.

For us, that is “Sensor Intelligence.”

WORLDWIDE PRESENCE:

Contacts and other locations –www.sick.com