



# ZLD18-4AB4A8

SimpleSense

HYBRID PHOTOELECTRIC SENSORS

**SICK**  
Sensor Intelligence.



Illustration may differ



### Ordering information

Type	Part no.
ZLD18-4AB4A8	1095740

**Included in delivery:** BEF-MU-M18\*1 (1)

Other models and accessories → [www.sick.com/SimpleSense](http://www.sick.com/SimpleSense)

### Detailed technical data

#### Features

<b>Device type</b>	Photoelectric sensors
<b>Sensor/ detection principle</b>	Photoelectric retro-reflective sensor, Dual lens
<b>Dimensions (W x H x D)</b>	13.6 mm x 44.2 mm x 33.3 mm
<b>Housing design (light emission)</b>	Hybrid
<b>Thread diameter (housing)</b>	M18
<b>Mounting system type</b>	M18, nose / M18, base
<b>Housing color</b>	Blue
<b>Sensing range max.</b>	0 m ... 5 m <sup>1)</sup>
<b>Sensing range</b>	0 m ... 4.2 m <sup>1)</sup>
<b>Type of light</b>	Visible red light
<b>Light source</b>	LED
<b>Light spot size (distance)</b>	Ø 125 mm (1,000 mm)
<b>Wave length</b>	625 nm

<sup>1)</sup> Reflector PL80A.

#### Mechanics/electronics

<b>Supply voltage</b>	10 V DC ... 30 V DC
<b>Ripple</b>	< 10 %
<b>Current consumption</b>	≤ 15 mA <sup>1)</sup>
<b>Switching output</b>	Push-pull: PNP/NPN
<b>Switching mode</b>	Light switching

<sup>1)</sup> Without load.

<sup>2)</sup> Signal transit time with resistive load.

<sup>3)</sup> With light/dark ratio 1:1.

<sup>4)</sup> A = V<sub>S</sub> connections reverse-polarity protected.

<sup>5)</sup> B = inputs and output reverse-polarity protected.

<sup>6)</sup> D = outputs overcurrent and short-circuit protected.

	Dark switching
<b>Switching output detail</b>	
Switching output Q1	Push-pull: PNP/NPN, Light switching
Switching output Q2	Push-pull: PNP/NPN, Dark switching
<b>Output current <math>I_{\max}</math></b>	100 mA
<b>Response time</b>	$\leq 500 \mu\text{s}$ <sup>2)</sup>
<b>Switching frequency</b>	1,000 kHz <sup>3)</sup>
<b>Connection type</b>	Male connector M12, 4-pin
<b>Circuit protection</b>	A <sup>4)</sup> B <sup>5)</sup> D <sup>6)</sup>
<b>Protection class</b>	III
<b>Weight</b>	4.54 g
<b>Polarisation filter</b>	✓
<b>Housing material</b>	Plastic, ABS
<b>Optics material</b>	Plastic, PMMA
<b>Enclosure rating</b>	IP67
<b>Ambient operating temperature</b>	-40 °C ... +55 °C
<b>Ambient temperature, storage</b>	-40 °C ... +70 °C
<b>UL File No.</b>	E189383

1) Without load.

2) Signal transit time with resistive load.

3) With light/dark ratio 1:1.

4) A = V<sub>S</sub> connections reverse-polarity protected.

5) B = inputs and output reverse-polarity protected.

6) D = outputs overcurrent and short-circuit protected.

## Classifications

<b>eCl@ss 5.0</b>	27270902
<b>eCl@ss 5.1.4</b>	27270902
<b>eCl@ss 6.0</b>	27270902
<b>eCl@ss 6.2</b>	27270902
<b>eCl@ss 7.0</b>	27270902
<b>eCl@ss 8.0</b>	27270902
<b>eCl@ss 8.1</b>	27270902
<b>eCl@ss 9.0</b>	27270902
<b>eCl@ss 10.0</b>	27270902
<b>eCl@ss 11.0</b>	27270902
<b>eCl@ss 12.0</b>	27270902
<b>ETIM 5.0</b>	EC002717
<b>ETIM 6.0</b>	EC002717
<b>ETIM 7.0</b>	EC002717
<b>ETIM 8.0</b>	EC002717
<b>UNSPSC 16.0901</b>	39121528

### Connection/pin assignment

<b>Connection type</b>	Male connector M12, 4-pin
<b>Pin assignment</b>	
BN 1	+ (L+)
WH 2	Q <sub>2</sub>
BU 3	- (M)
BK 4	Q <sub>1</sub>

### Dimensional drawing (Dimensions in mm (inch))

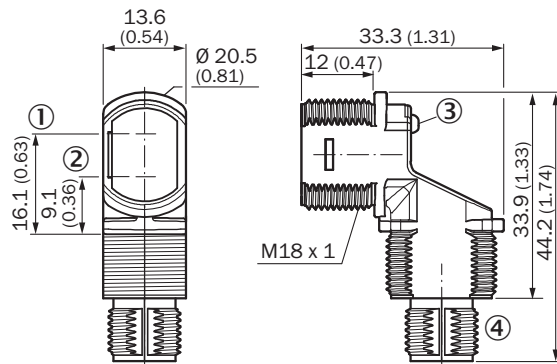

- ① Optical axis, sender
- ② Optical axis, receiver
- ③ LED status indicator
- ④ Connection

### Connection type

Connection type. see table: Connection/PIN assignment

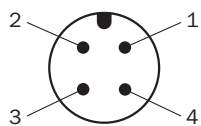

M12 male connector, 4-pin, A-coding

### Characteristic curve

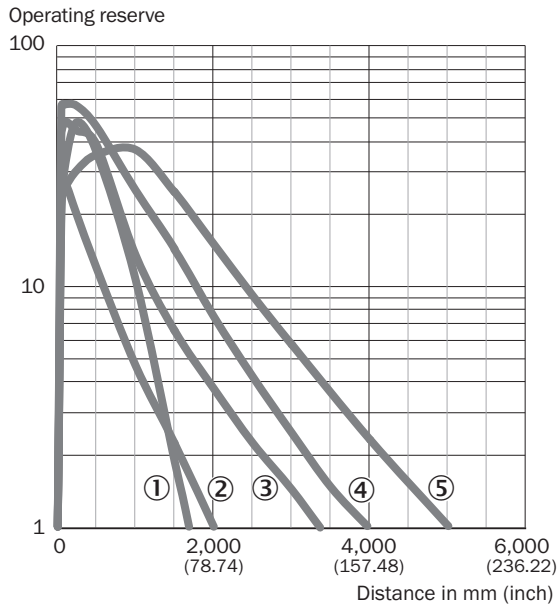

- ① Reflector PL23 FT
- ② Reflector PL20A
- ③ Reflector PL250
- ④ Reflector PL40A
- ⑤ Reflector PL80A



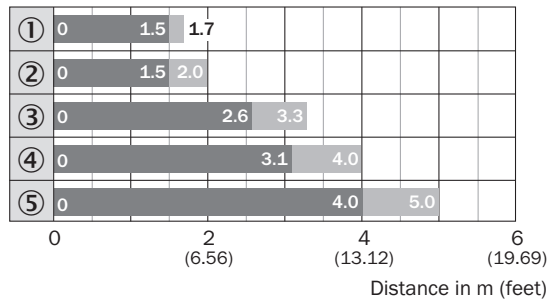

### Sensing range diagram



- Sensing range
- Sensing range max.
- ① Reflector PL23 FT
- ② Reflector PL20A
- ③ Reflector PL250
- ④ Reflector PL40A
- ⑤ Reflector PL80A

### Recommended accessories

Other models and accessories → [www.sick.com/SimpleSense](http://www.sick.com/SimpleSense)

	Brief description	Type	Part no.
<b>Mounting brackets and plates</b>			
	Universal mounting bracket for reflectors, steel, zinc coated	BEF-WN-REFX	2064574
<b>Plug connectors and cables</b>			
	Head A: female connector, M12, 4-pin, straight, A-coded Head B: Flying leads Cable: Sensor/actuator cable, PVC, unshielded, 5 m	YF2A14-050VB3XLEAX	2096235
	Head A: male connector, M12, 4-pin, straight Cable: unshielded	STE-1204-G	6009932
<b>Reflectors</b>			
	Rectangular, screw connection, 51 mm x 61 mm, PMMA/ABS, Screw-on, 2 hole mounting	P250	5304812

## SICK AT A GLANCE

SICK is one of the leading manufacturers of intelligent sensors and sensor solutions for industrial applications. A unique range of products and services creates the perfect basis for controlling processes securely and efficiently, protecting individuals from accidents and preventing damage to the environment.

We have extensive experience in a wide range of industries and understand their processes and requirements. With intelligent sensors, we can deliver exactly what our customers need. In application centers in Europe, Asia and North America, system solutions are tested and optimized in accordance with customer specifications. All this makes us a reliable supplier and development partner.

Comprehensive services complete our offering: SICK LifeTime Services provide support throughout the machine life cycle and ensure safety and productivity.

For us, that is “Sensor Intelligence.”

## WORLDWIDE PRESENCE:

Contacts and other locations –[www.sick.com](http://www.sick.com)