



# IMB18-12NDSVU2S

IMB

INDUCTIVE PROXIMITY SENSORS

**SICK**  
Sensor Intelligence.



Illustration may differ



## Ordering information

| Type            | Part no. |
|-----------------|----------|
| IMB18-12NDSVU2S | 1074375  |

**Included in delivery:** BEF-MU-M18N (1)

Other models and accessories → [www.sick.com/IMB](http://www.sick.com/IMB)

## Detailed technical data

### Features

|  |   |
|--|---|
| <b>Housing</b>                             | Cylindrical thread design   |
| <b>Housing</b>                             | Standard  |
| <b>Thread size</b>                         | M18 x 1   |
| <b>Diameter</b>                            | Ø 18 mm   |
| <b>Sensing range <math>S_n</math></b>      | 12 mm   |
| <b>Safe sensing range <math>S_a</math></b> | 9.72 mm   |
| <b>Installation type</b>                   | Non-flush   |
| <b>Switching frequency</b>                 | 1,000 Hz  |
| <b>Connection type</b>                     | Cable, 2-wire, 2 m  |
| <b>Output function</b>                     | NO  |
| <b>Electrical wiring</b>                   | DC 2-wire   |
| <b>Enclosure rating</b>                    | IP68 <sup>1)</sup><br>IP69K <sup>2)</sup>   |
| <b>Special features</b>                    | Resistant against coolant lubricants, Visual adjustment indicator, Temperature resistance |
| <b>Special applications</b>                | Zones with coolants and lubricants, Mobile machines, Difficult application conditions     |

<sup>1)</sup> According to EN 60529.

<sup>2)</sup> According to ISO 20653:2013-03.

### Mechanics/electronics

|                                       |  |
|---------------------------------------|--|
| <b>Supply voltage</b>                 | 10 V DC ... 30 V DC                          |
| <b>Ripple</b>                         | ≤ 10 %                                       |
| <b>Voltage drop</b>                   | ≤ 4 V <sup>1)</sup><br>≤ 4.5 V <sup>2)</sup> |
| <b>Time delay before availability</b> | ≤ 100 ms                                     |

<sup>1)</sup> At  $I_a = 30$  mA.

<sup>2)</sup> At  $I_a$  max.

<sup>3)</sup>  $U_b$  and  $T_a$  constant.

<sup>4)</sup> Of  $S_r$ .

<sup>5)</sup> When using the non-toothed side of the nut.

<sup>6)</sup> Valid if toothed side of nut is used.

|   |  |
|---|--|
| <b>Hysteresis</b>                           | 3 % ... 20 %   |
| <b>Reproducibility</b>                      | ≤ 2 % <sup>3) 4)</sup>   |
| <b>Temperature drift (of S<sub>r</sub>)</b> | ± 10 %   |
| <b>EMC</b>                                  | According to EN 60947-5-2  |
| <b>Continuous current I<sub>a</sub></b>     | ≤ 100 mA   |
| <b>Off-state current</b>                    | Typ. 0.8 mA (≤ 1.2 mA at U <sub>b</sub> max and 100 ° C)   |
| <b>Minimum load current</b>                 | ≥ 3 mA   |
| <b>Cable material</b>                       | PUR  |
| <b>Short-circuit protection</b>             | ✓  |
| <b>Reverse polarity protection</b>          | ✓  |
| <b>Power-up pulse</b>                       | ≤ 5 ms   |
| <b>Shock and vibration resistance</b>       | 100 g / 2 ms / 500 cycles; 150 g / 1 Mio cycles; 10 Hz ... 55 Hz / 1 mm; 55 Hz ... 500 Hz / 60 g |
| <b>Ambient operating temperature</b>        | -40 °C ... +100 °C   |
| <b>Housing material</b>                     | Stainless steel V2A, DIN 1.4305 / AISI 303   |
| <b>Sensing face material</b>                | Plastic, LCP   |
| <b>Housing length</b>                       | 50 mm  |
| <b>Thread length</b>                        | 38 mm  |
| <b>Tightening torque, max.</b>              | Typ. 60 Nm <sup>5)</sup><br>Typ. 90 Nm <sup>6)</sup>   |
| <b>Items supplied</b>                       | Mounting nut, V2A stainless steel, with locking teeth (2x)                                       |
| <b>Protection class</b>                     | III  |
| <b>UL File No.</b>                          | E181493  |

<sup>1)</sup> At I<sub>a</sub> = 30 mA.

<sup>2)</sup> At I<sub>a</sub> max.

<sup>3)</sup> U<sub>b</sub> and T<sub>a</sub> constant.

<sup>4)</sup> Of S<sub>r</sub>.

<sup>5)</sup> When using the non-toothed side of the nut.

<sup>6)</sup> Valid if toothed side of nut is used.

### Safety-related parameters

|                         |             |
|-------------------------|-------------|
| <b>MTTF<sub>D</sub></b> | 1,287 years |
| <b>DC<sub>avg</sub></b> | 0 %         |

### Reduction factors

|                                   |  |
|-----------------------------------|--|
| <b>Note</b>                       | The values are reference values which may vary |
| <b>St37 steel (Fe)</b>            | 1  |
| <b>Stainless steel (V2A, 304)</b> | Approx. 0.7                                    |
| <b>Aluminum (Al)</b>              | Approx. 0.43                                   |
| <b>Copper (Cu)</b>                | Approx. 0.37                                   |
| <b>Brass (Br)</b>                 | Approx. 0.43                                   |

### Installation note

|               |                                       |
|---------------|---------------------------------------|
| <b>Remark</b> | Associated graphic see "Installation" |
| <b>A</b>      | 18 mm                                 |

|          |       |
|----------|-------|
| <b>B</b> | 45 mm |
| <b>C</b> | 18 mm |
| <b>D</b> | 36 mm |
| <b>E</b> | 12 mm |
| <b>F</b> | 96 mm |

Classifications

|                       |          |
|-----------------------|----------|
| <b>ECl@ss 5.0</b>     | 27270101 |
| <b>ECl@ss 5.1.4</b>   | 27270101 |
| <b>ECl@ss 6.0</b>     | 27270101 |
| <b>ECl@ss 6.2</b>     | 27270101 |
| <b>ECl@ss 7.0</b>     | 27270101 |
| <b>ECl@ss 8.0</b>     | 27270101 |
| <b>ECl@ss 8.1</b>     | 27270101 |
| <b>ECl@ss 9.0</b>     | 27270101 |
| <b>ECl@ss 10.0</b>    | 27270101 |
| <b>ECl@ss 11.0</b>    | 27270101 |
| <b>ETIM 5.0</b>       | EC002714 |
| <b>ETIM 6.0</b>       | EC002714 |
| <b>ETIM 7.0</b>       | EC002714 |
| <b>ETIM 8.0</b>       | EC002714 |
| <b>UNSPSC 16.0901</b> | 39122230 |

Installation note

Non-flush installation

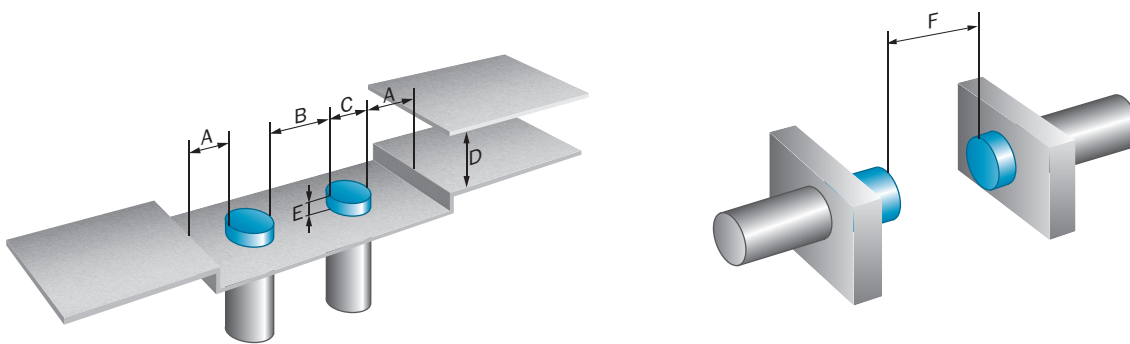

### Connection diagram

Cd-012

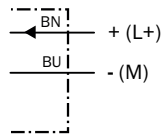

### Characteristic curve

Response diagram

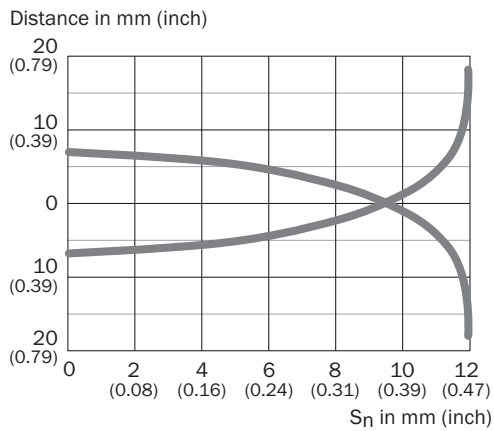

### Adjustments

Installation aid

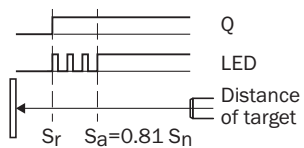





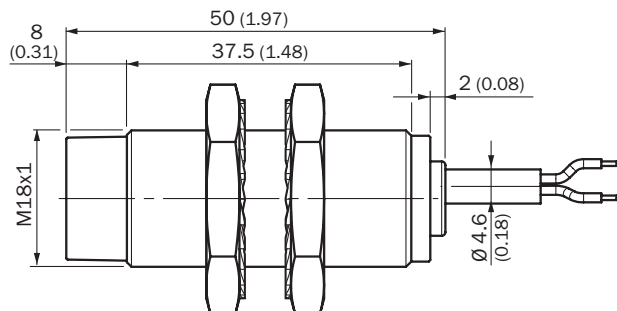

### Dimensional drawing (Dimensions in mm (inch))

IMB18 Standard, cable, non-flush



**Recommended accessories**

Other models and accessories → [www.sick.com/IMB](http://www.sick.com/IMB)

|   | <b>Brief description</b>  | <b>Type</b>  | <b>Part no.</b> |
|---|---|--------------|-----------------|
| <b>Universal bar clamp systems</b>  |   |              |                 |
|    | Plate N06N for universal clamp bracket, M18, Stainless steel 1.4571 (sheet), Stainless steel 1.4408 (clamp), Universal clamp (5322627), mounting hardware | BEF-KHS-N06N | 2051622         |
| <b>Mounting brackets and plates</b>   |   |              |                 |
|    | Mounting plate for M18 sensors, stainless steel, without mounting hardware  | BEF-WG-M18N  | 5320948         |
|    | Mounting bracket for M18 sensors, stainless steel, without mounting hardware  | BEF-WN-M18N  | 5320947         |
| <b>Plug connectors and cables</b>   |   |              |                 |
|    | Head A: female connector, M12, 4-pin, straight<br>Head B: -<br>Cable: unshielded  | DOS-1204-GN  | 6028357         |
|    | Head A: female connector, M12, 4-pin, angled<br>Head B: -<br>Cable: unshielded  | DOS-1204-WN  | 6028358         |
|  | Head A: male connector, M12, 4-pin, straight<br>Head B: -<br>Cable: unshielded  | STE-1204-GN  | 6028359         |
|  | Head A: male connector, M12, 4-pin, straight<br>Head B: -<br>Cable: unshielded<br>For 2 cable connections   | STE-1204-TN  | 6028360         |

## SICK AT A GLANCE

SICK is one of the leading manufacturers of intelligent sensors and sensor solutions for industrial applications. A unique range of products and services creates the perfect basis for controlling processes securely and efficiently, protecting individuals from accidents and preventing damage to the environment.

We have extensive experience in a wide range of industries and understand their processes and requirements. With intelligent sensors, we can deliver exactly what our customers need. In application centers in Europe, Asia and North America, system solutions are tested and optimized in accordance with customer specifications. All this makes us a reliable supplier and development partner.

Comprehensive services complete our offering: SICK LifeTime Services provide support throughout the machine life cycle and ensure safety and productivity.

For us, that is “Sensor Intelligence.”

## WORLDWIDE PRESENCE:

Contacts and other locations –[www.sick.com](http://www.sick.com)